

FIREPLACE INSERTS FROM BRUNNER



BKH Eck 50-82-42 green lifting door

State: 2024-03-18



BRUNNER[®]
made in germany.

Dimension sheets - BKH Eck 50-82-42 green lifting door

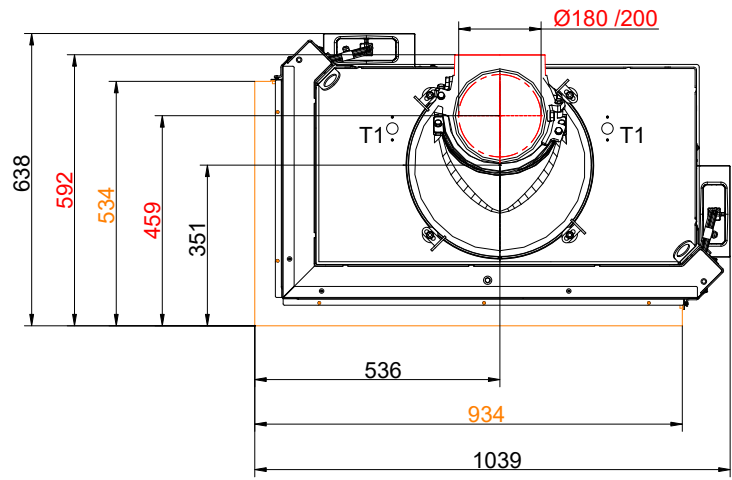
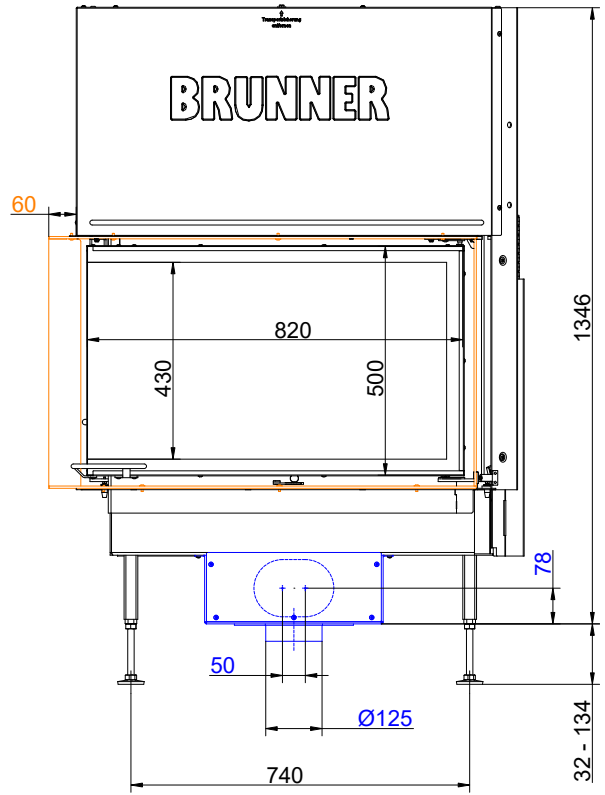
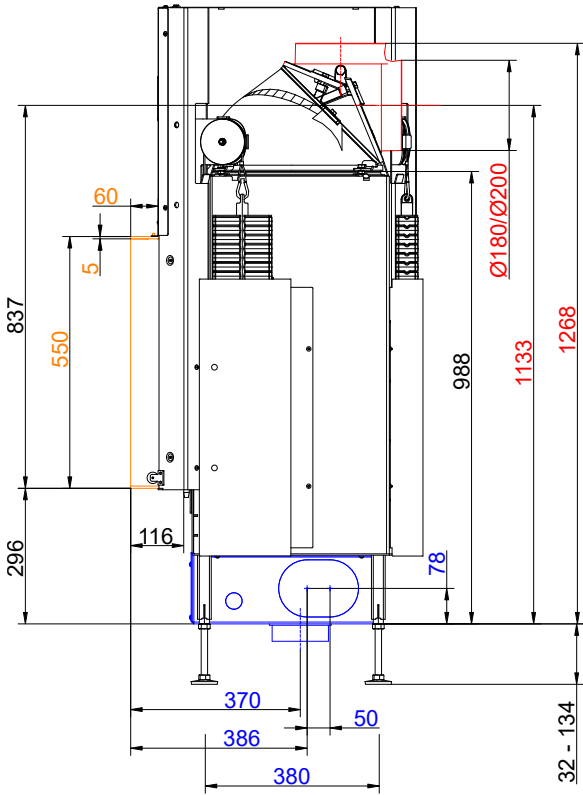

... left with mounting frame and Cast iron dome

Dimension sheets - BKH Eck 50-82-42 green lifting door

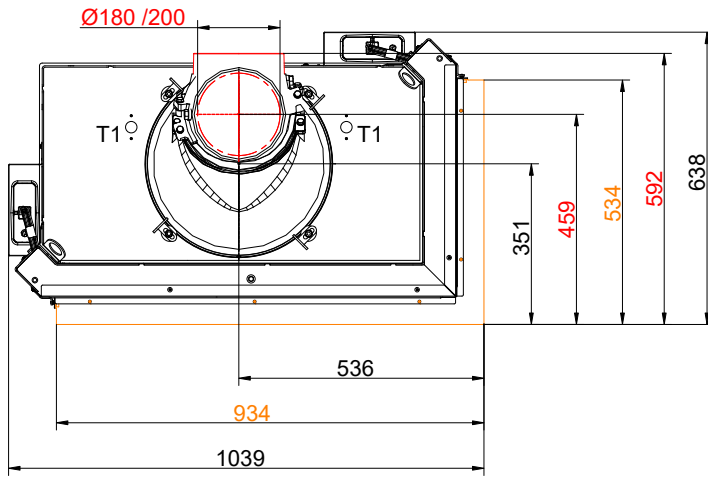
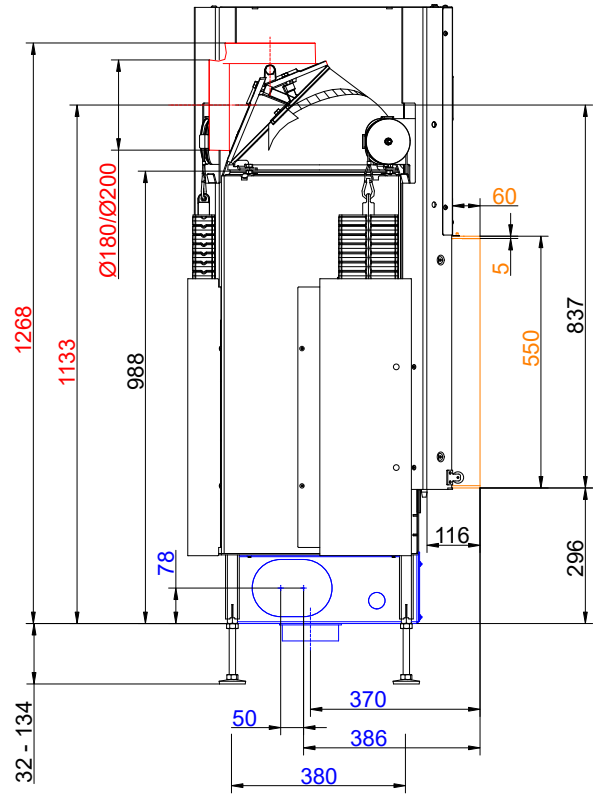
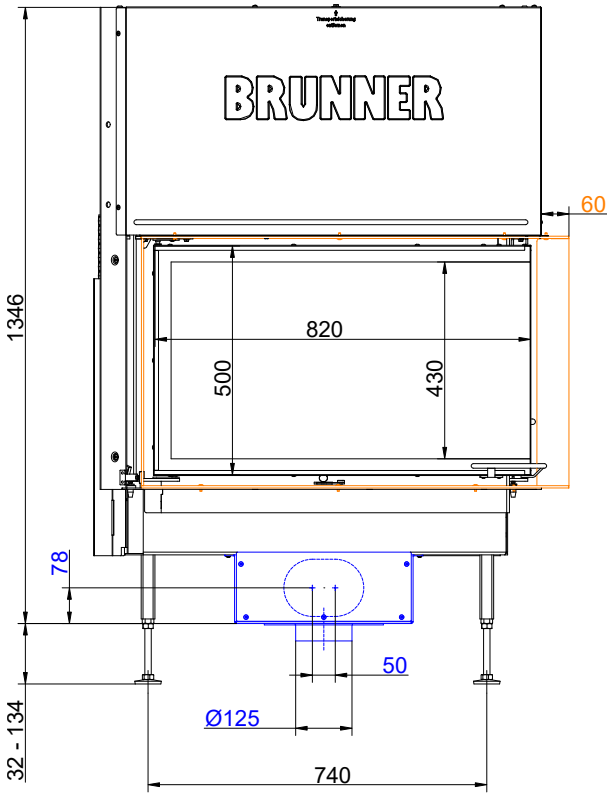

... right with mounting frame and Cast iron dome

Dimension sheets - BKH Eck 50-82-42 green lifting door

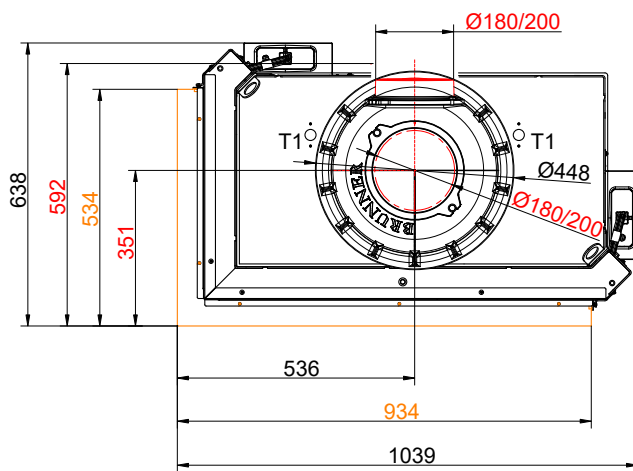
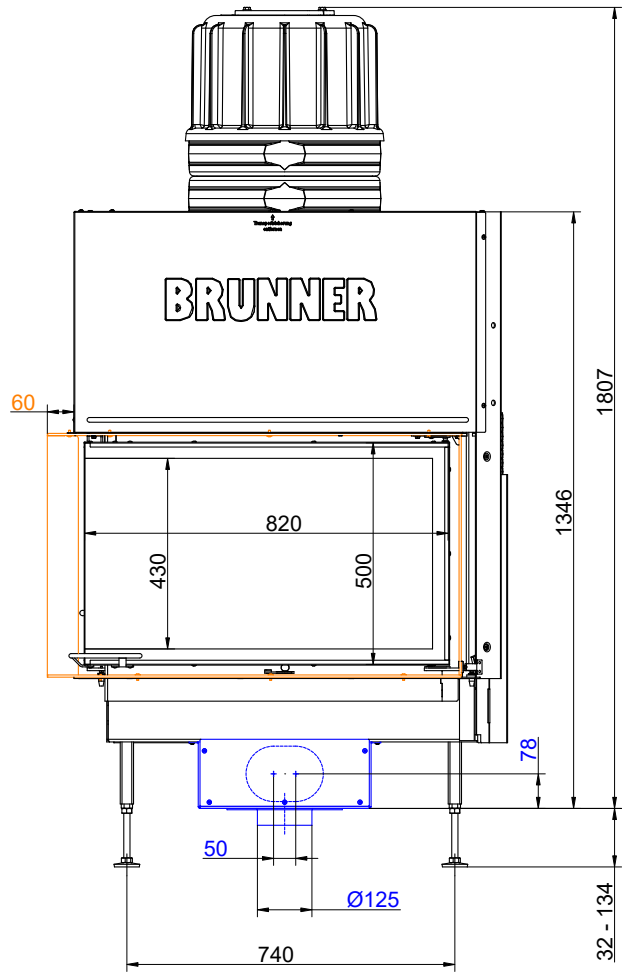
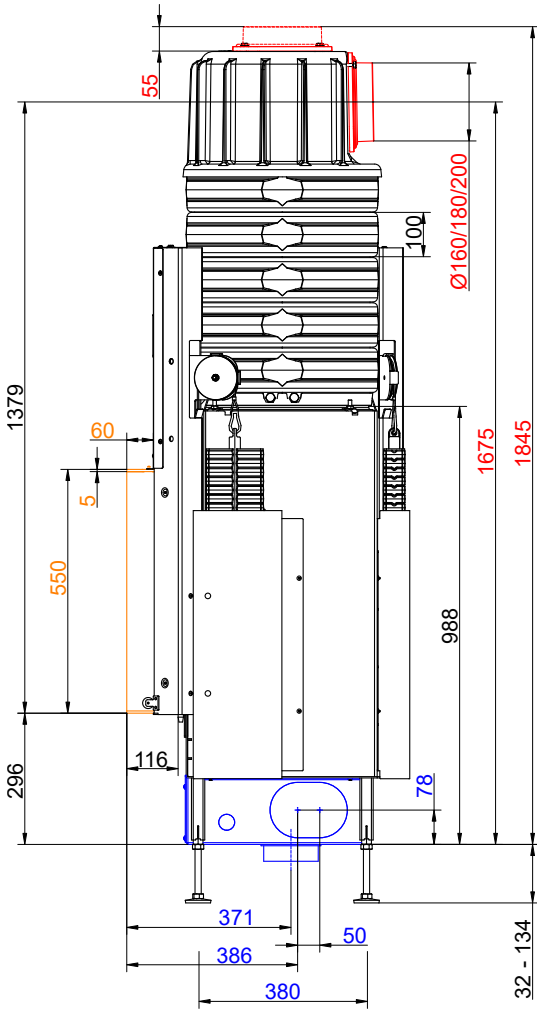

... left with mounting frame and MAS

Dimension sheets - BKH Eck 50-82-42 green lifting door

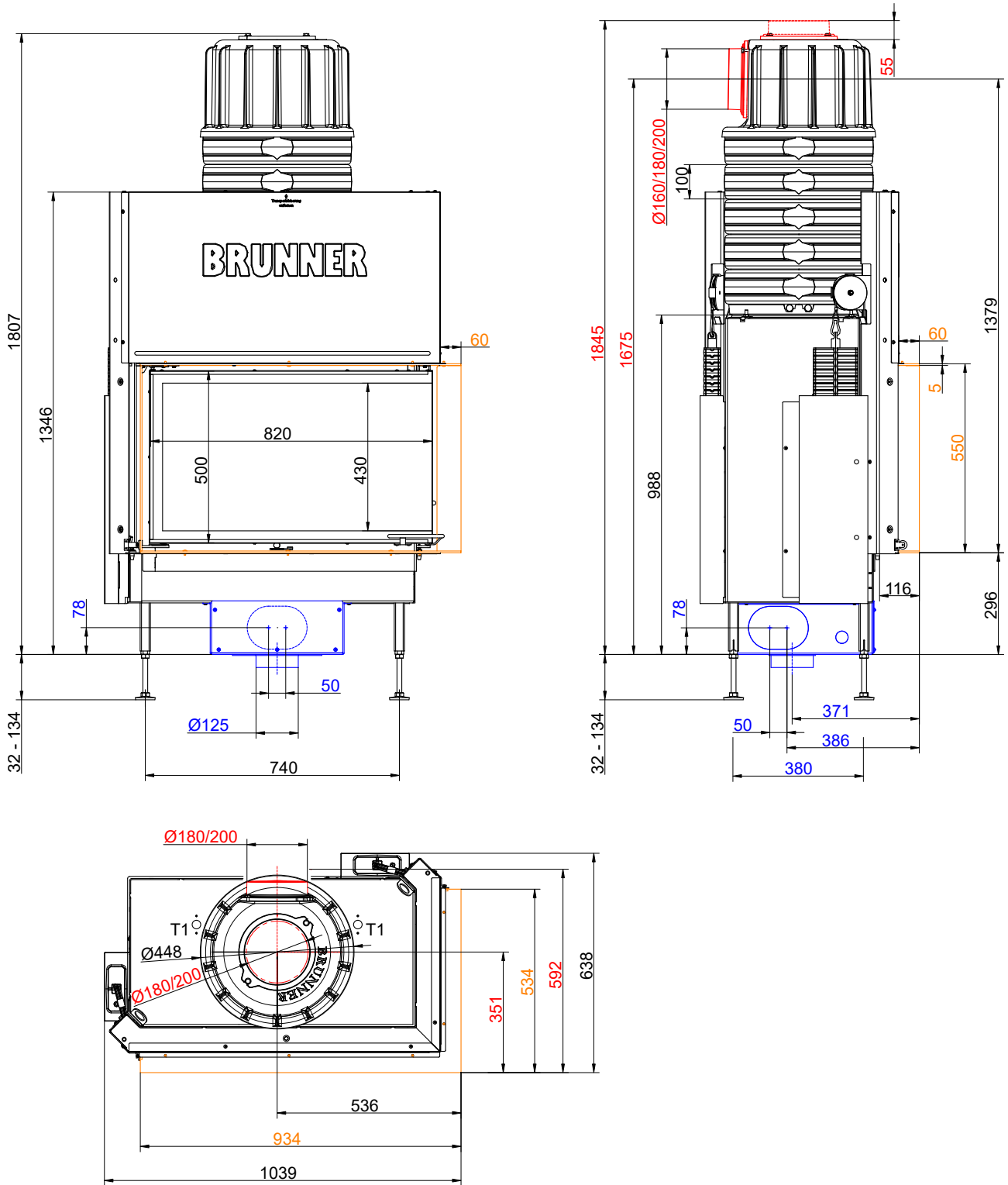

... right with mounting frame and MAS

Dimension sheets - BKH Eck 50-82-42 green lifting door

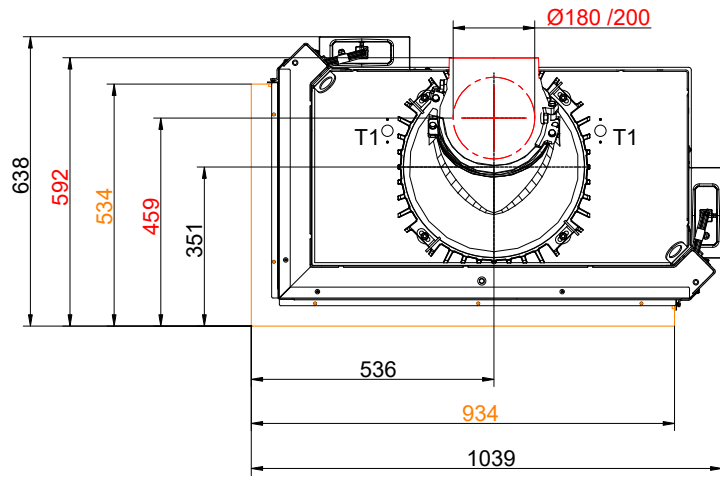
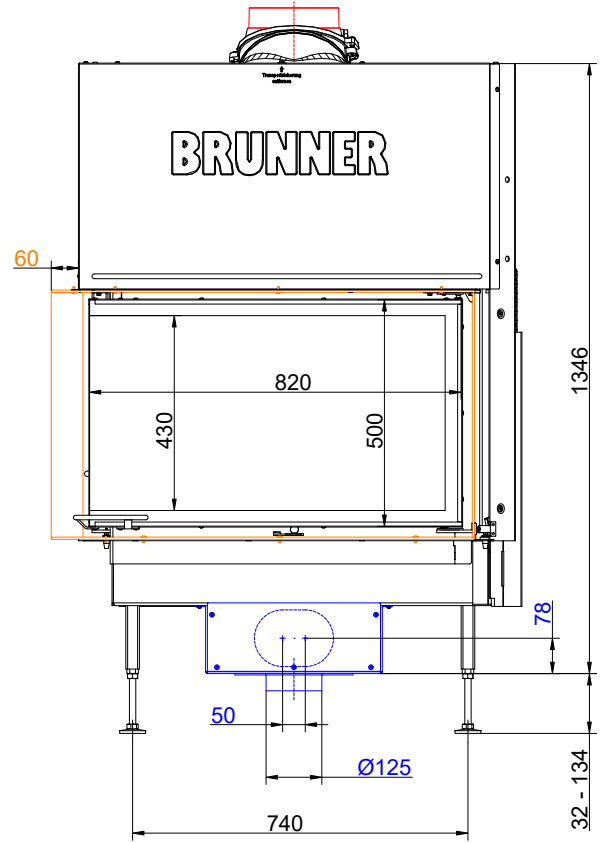
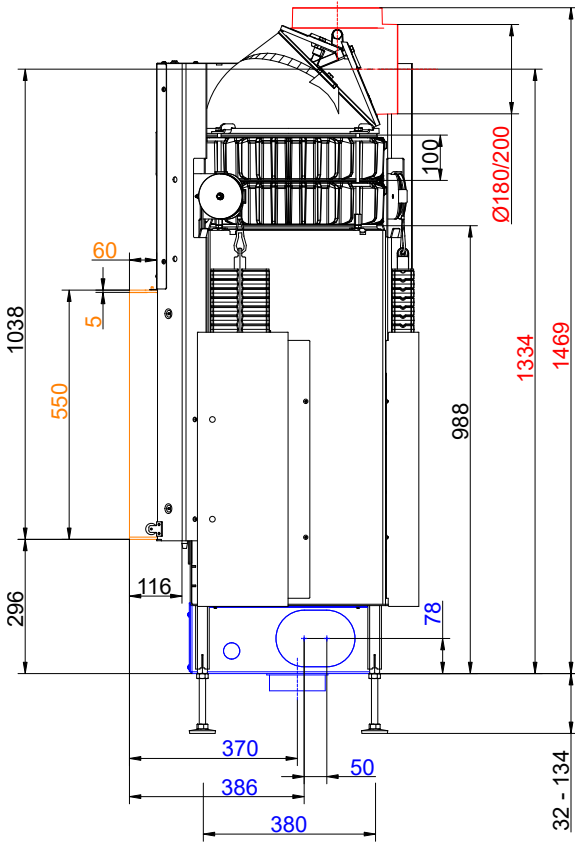

... left with mounting frame and cast iron heat exchanger rings + dome

Dimension sheets - BKH Eck 50-82-42 green lifting door

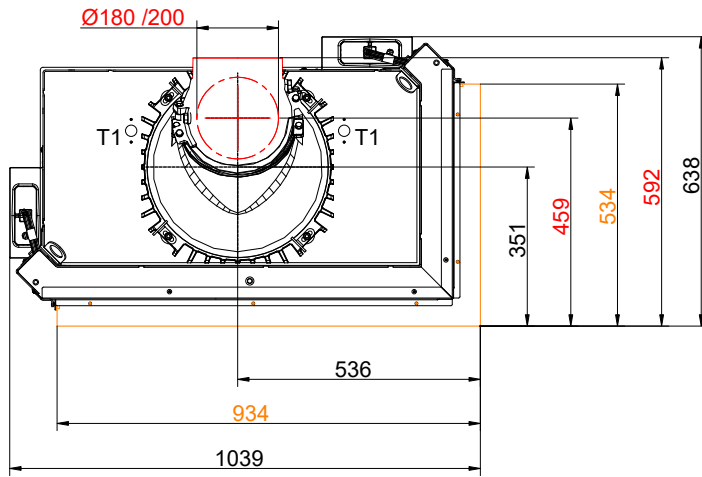
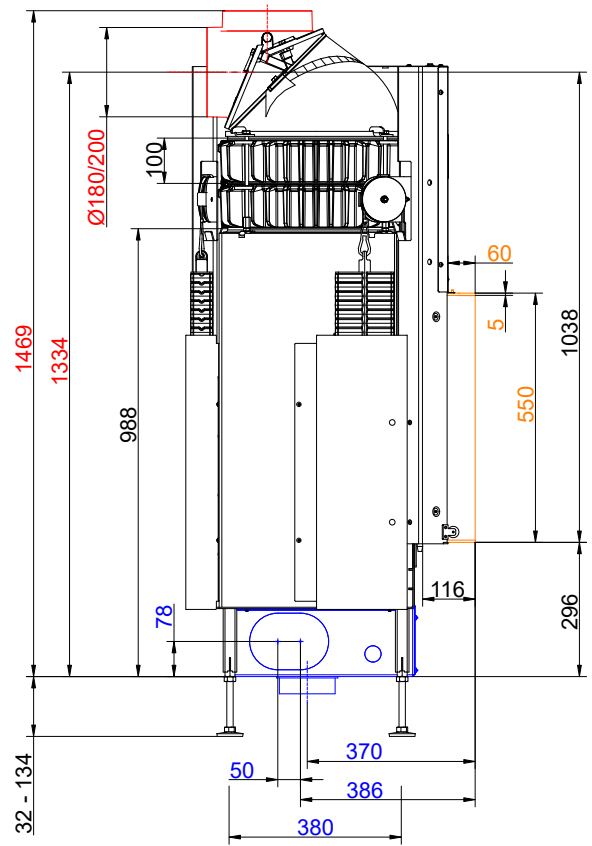
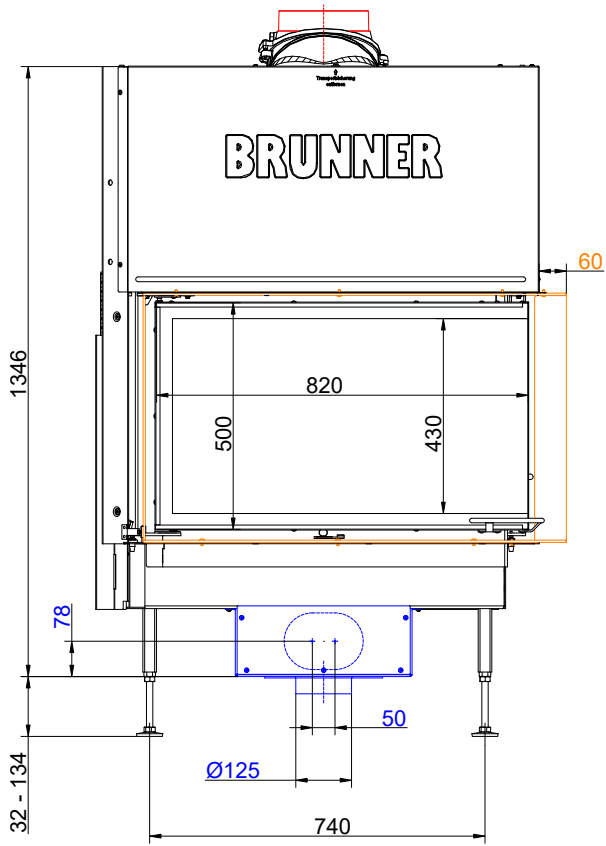

... right with mounting frame and cast iron heat exchanger rings + dome

We suggest for CAD planning Palette CAD. Permanent updated drawings: www.brunner.de

Frames/ flue gas outlet connection/ combustion air supply connection/ front variants/ support bearing are marked in color.

Planning and installation - BKH Eck 50-82-42 green lifting door

Tested according to		EN 13229 W	EN 13229 WA
Values measured at		Rated power ¹⁾	Storage operation ²⁾
Data for functional demonstration			
Rated heat power	kW	10.0	-
Fire wood volume	kg/h	3.3	4.5
Combustion performance	kW	12.0	22
Flue gas mass flow	g/s	12.0	19
Flue gas temperature after:			
Cast iron dome	°C	250	350
4 x cast iron heat exchanger rings + dome	°C	210	260
5 x accumulation rings incl. MAS casted cover ³⁾	°C	-	260
2,0 m ceramic accumulator ⁴⁾	°C	-	180
1,4 m accumulation stones (MSS) ⁴⁾	°C	-	180
Necessary supply pressure	Pa	12	12
Fuel amount	kg	2.5	5.0
Combustion air consumption	m ³ /h	32	48
Combustion air connection Ø	mm	125	125
Heat distribution			
Insert / reheating surface	%	30 / 30	30 / 30
glass ceramic / glass ceramic coated (GKB)	%	40 / 35	40 / 35
Cross-section of gratings ⁵⁾			
exhaust warm air	cm ²	800	800
Recirculation air	cm ²	800	800
Minimal oven surface for closed construction type			
Heat dissipating surface	m ²	4.5	4.5
Minimal distances of the fireplace			
Heat protection panel for cladding, insulation layer	cm	3	3
to cladding, insulation layer	cm	5	5
to the floor (non-combustible)	cm	3	3
Minimum insulation thicknesses of substitute insulation material / reference insulation material + facing wall ⁶⁾			
with heat protection panel for mounting wall (non-combustible) ⁷⁾	cm	6 / 8	6 / 8
with heat protection panel for mounting wall (combustible) ⁷⁾	cm	12 / 13 + 10	12 / 13 + 10
to mounting wall (non-combustible)	cm	8 / 10	8 / 10
to mounting wall (combustible)	cm	18 / 20 + 10	18 / 20 + 10
to the ceiling (non-combustible)	cm	8 / 10	8 / 10
to the ceiling (combustible)	cm	22 / 25 + 10	22 / 25 + 10
to the floor (non-combustible)	cm	0 / 0	0 / 0
Minimum distances in front of the combustion chamber, glass ceramic / glass ceramic coated (GKB)			
for combustible parts	cm	≥ 120 / ≥ 80	≥ 120 / ≥ 80
Weight			
Fireplace insert + combustion chamber inner lining chamotte/cast iron	kg	213 + 76 / 88	
Meets requirement/limit values for:			
EU / Germany	Ecodesign / 1. BImSchV (Stufe 2)		

- 1) Indications to "Rated power" determined with 4 heat exchanger rings made of cast iron and Ø200 dome.
- 2) Indications to "Storage operation" for the manual execution of the reheating surface (guide values).
- 3) Damper flap recommended
- 4) Standard value or calculated functional proof required.
- 5) Air cross-sections if the specified nominal heat output is desired as the heat output.

Planning and installation - BKH Eck 50-82-42 green lifting door

- 6) Fire safety: values determined with air cross-sections evaluated by safety testing; stove cladding is heat emitting. Insulation material data with calcium silicate (Promasil 950KS)/10 cm wall lining + reference insulation material (mineral wool according to AGI Q 132). The specifications for walls/ceilings that do not require protection and are non-combustible correspond to the specifications of TROL (Germany).
- 7) Heat protection panels (accessories) only available for selected fireplace inserts. For assembly and design of the heat protection panel see assembly instructions. Distance between mounted heat protection panel and fireplace insert: rear wall 2 cm, side wall 3 cm.