

FIREPLACE INSERTS FROM BRUNNER



BKH flat 42-50 green

State: 2024-03-14



BRUNNER[®]
made in germany.

Dimension sheets - BKH flat 42-50 green

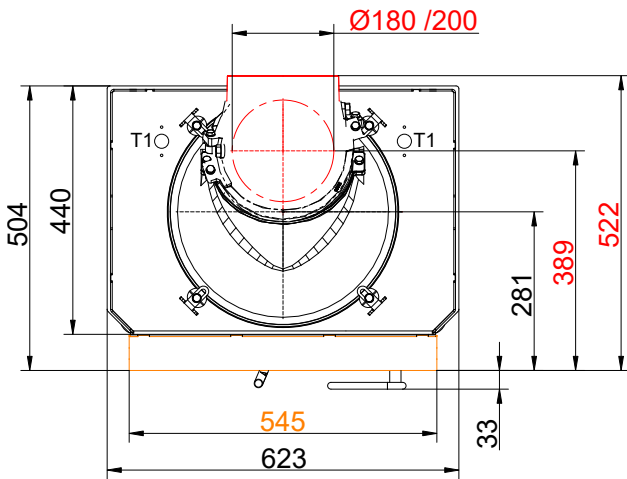
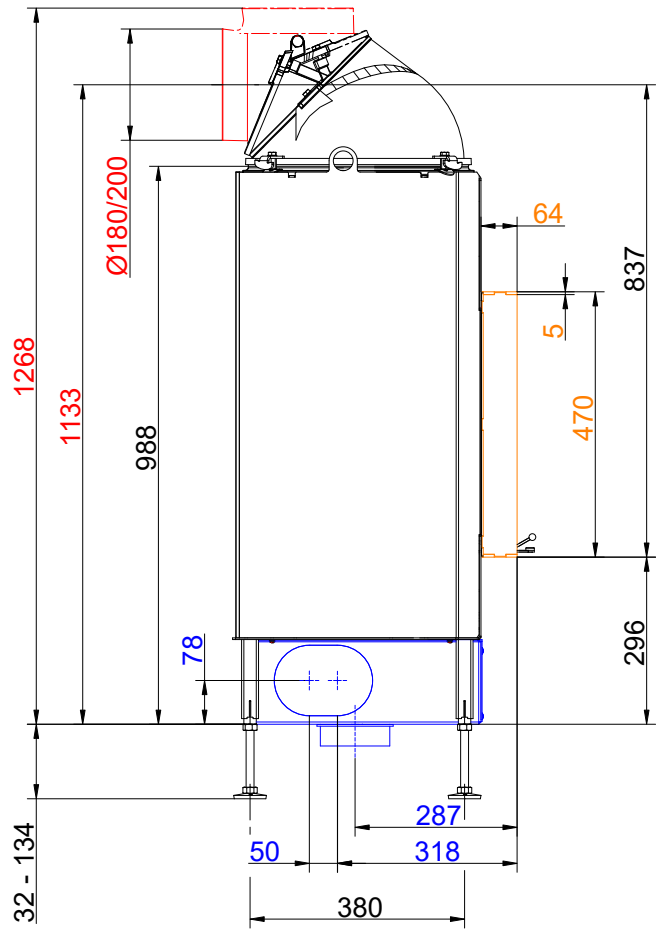
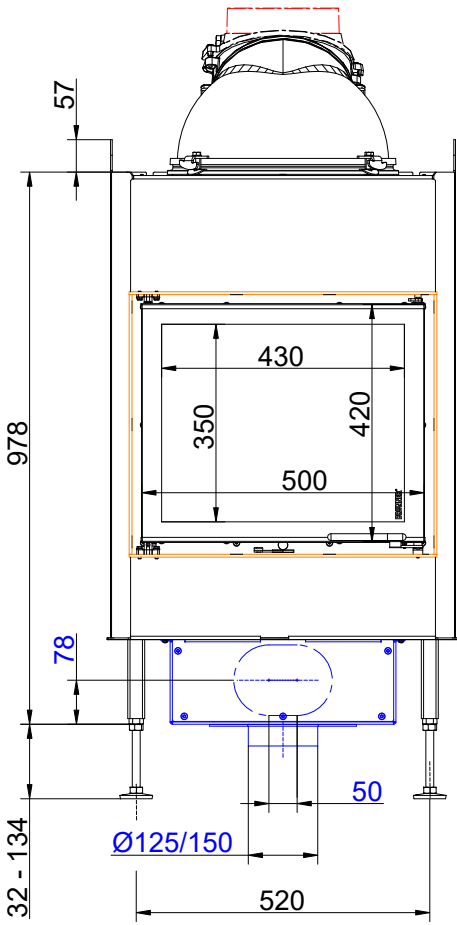

... mounting bracket with cast iron dome (side-opening door, DT)

Dimension sheets - BKH flat 42-50 green

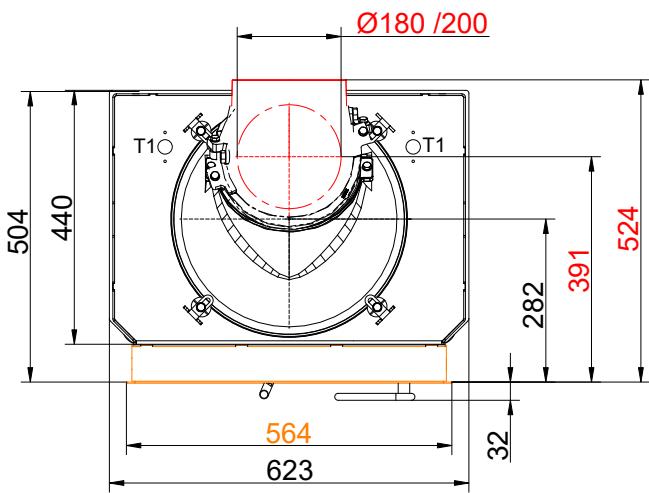
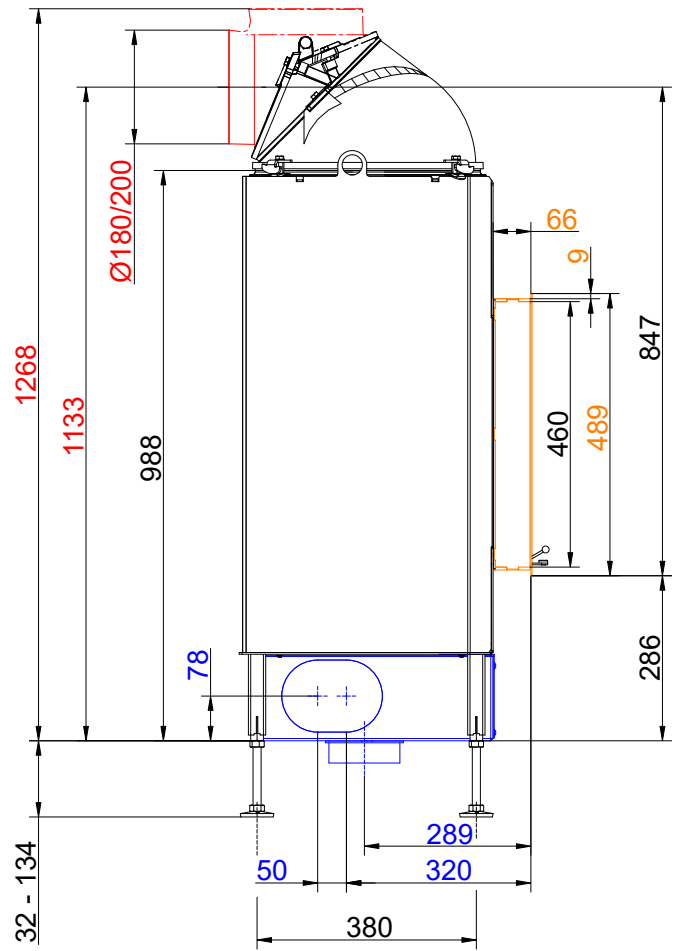
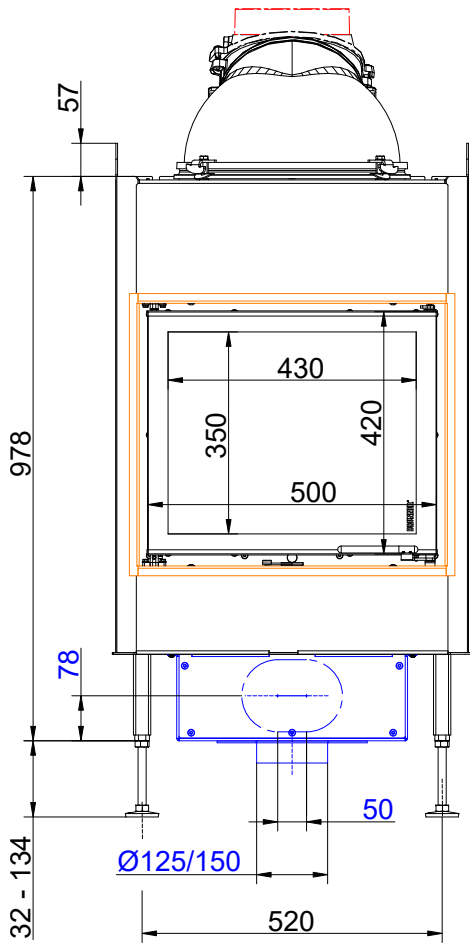

... door frame and cast iron dome (side-opening door, DT)

Dimension sheets - BKH flat 42-50 green

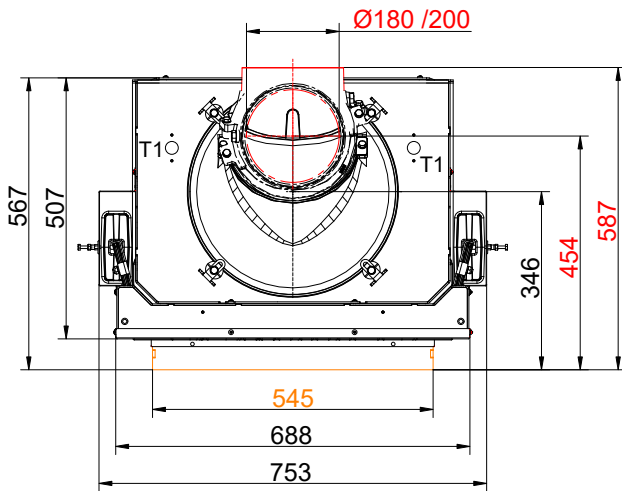
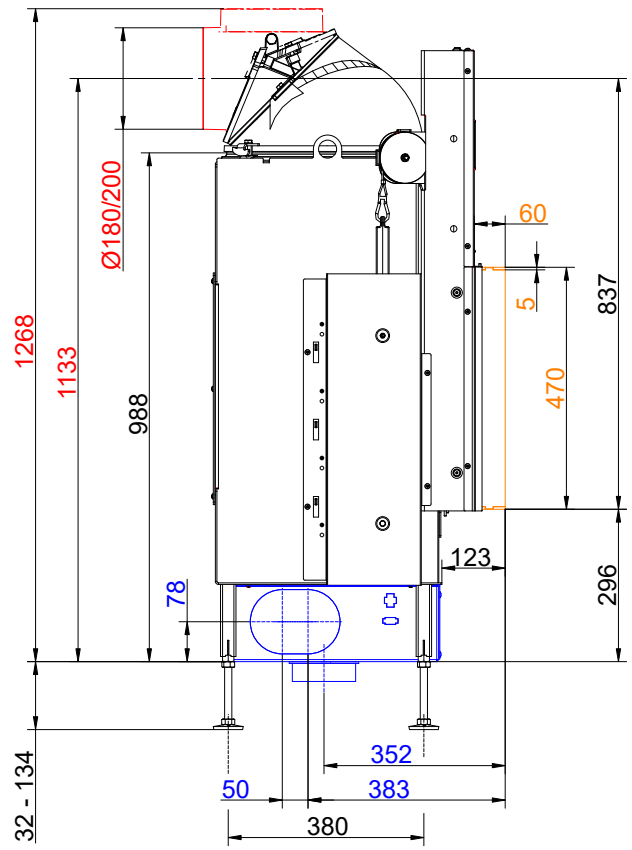
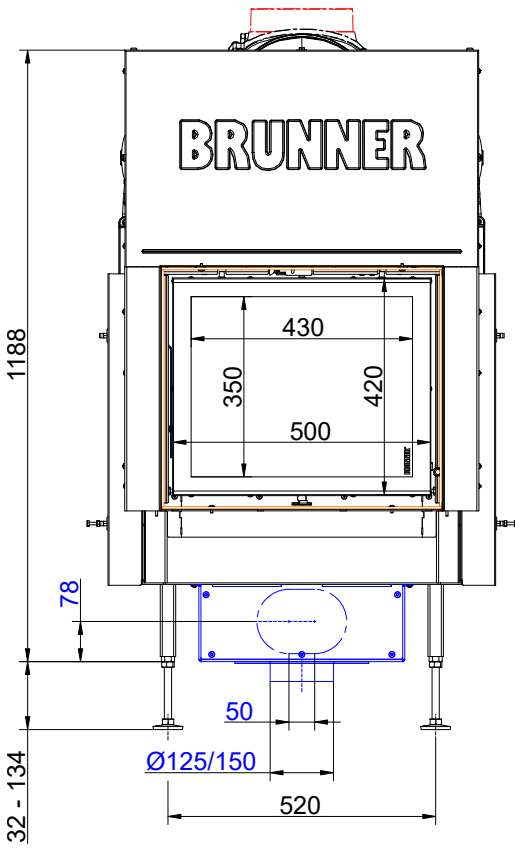

... mounting frame and cast iron dome (lifting door, ST)

Dimension sheets - BKH flat 42-50 green

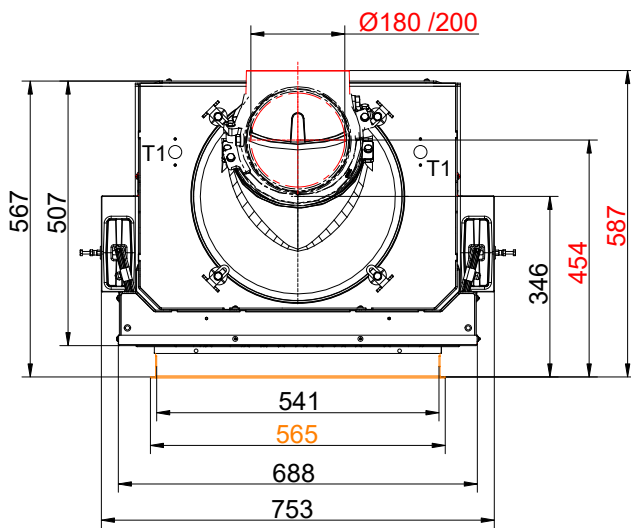
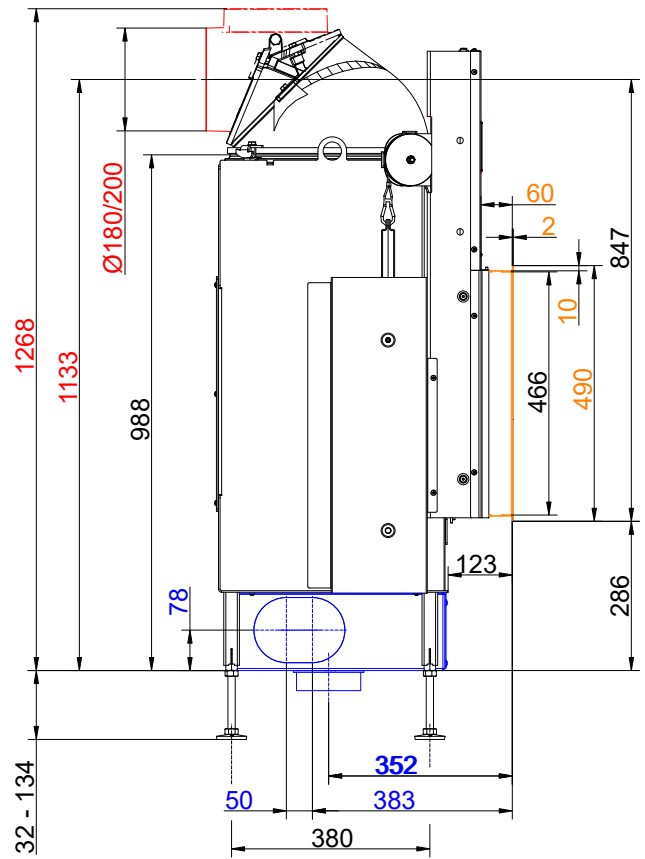
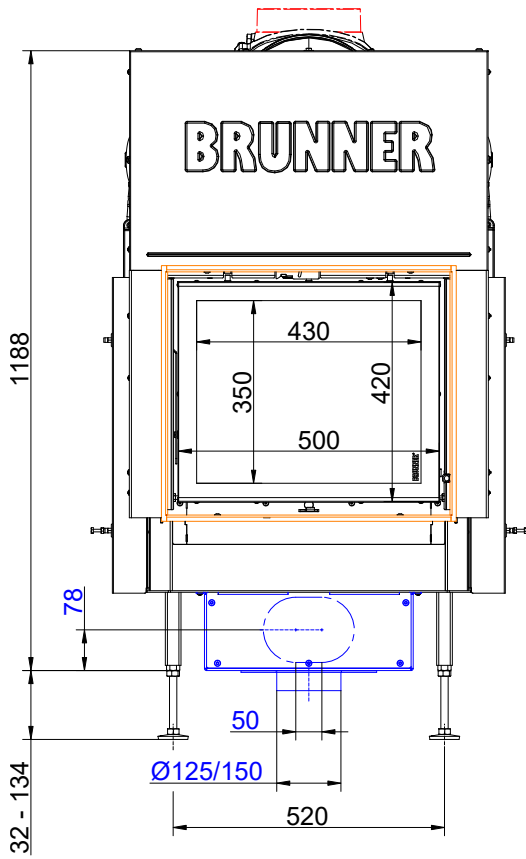

... door frame and cast iron dome (lifting door, ST)

Dimension sheets - BKH flat 42-50 green

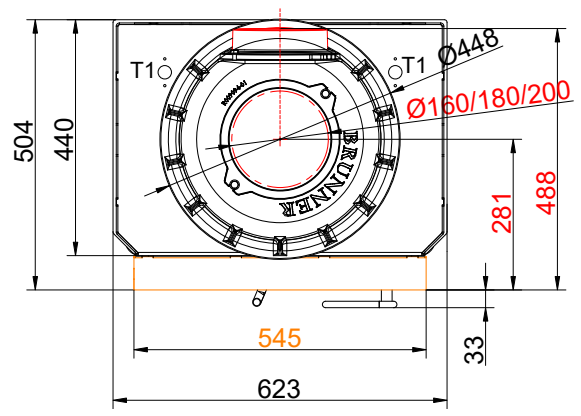
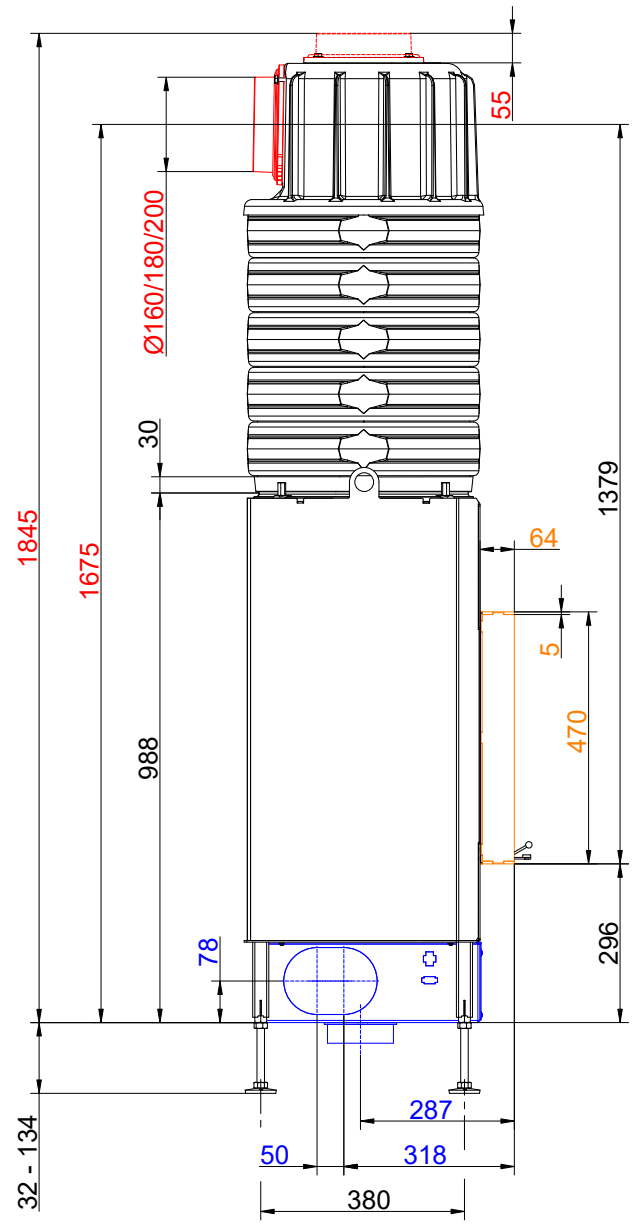
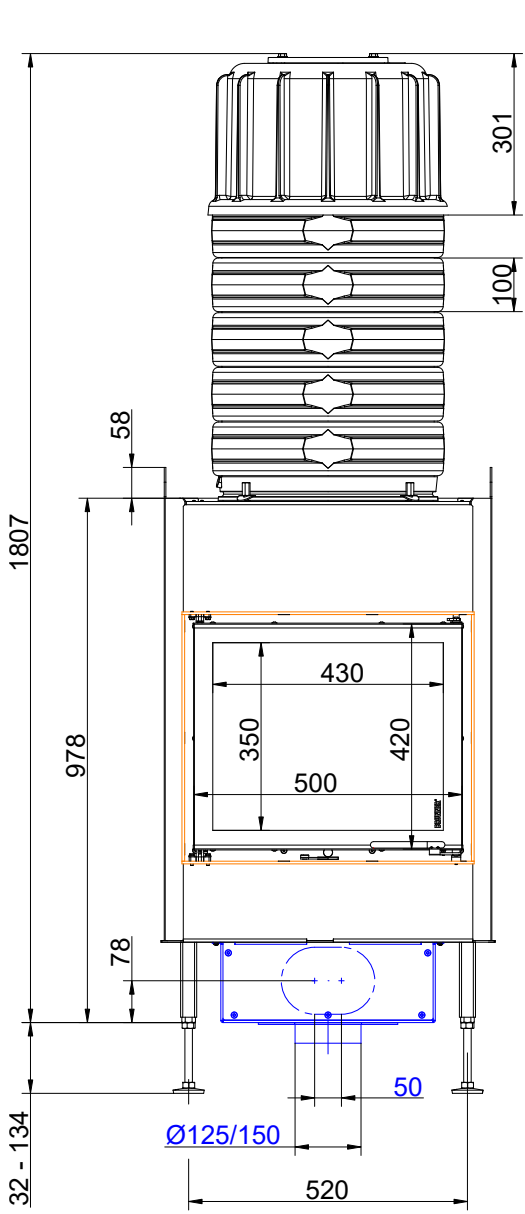

... mounting bracket and MAS (side-opening door, DT)

Dimension sheets - BKH flat 42-50 green

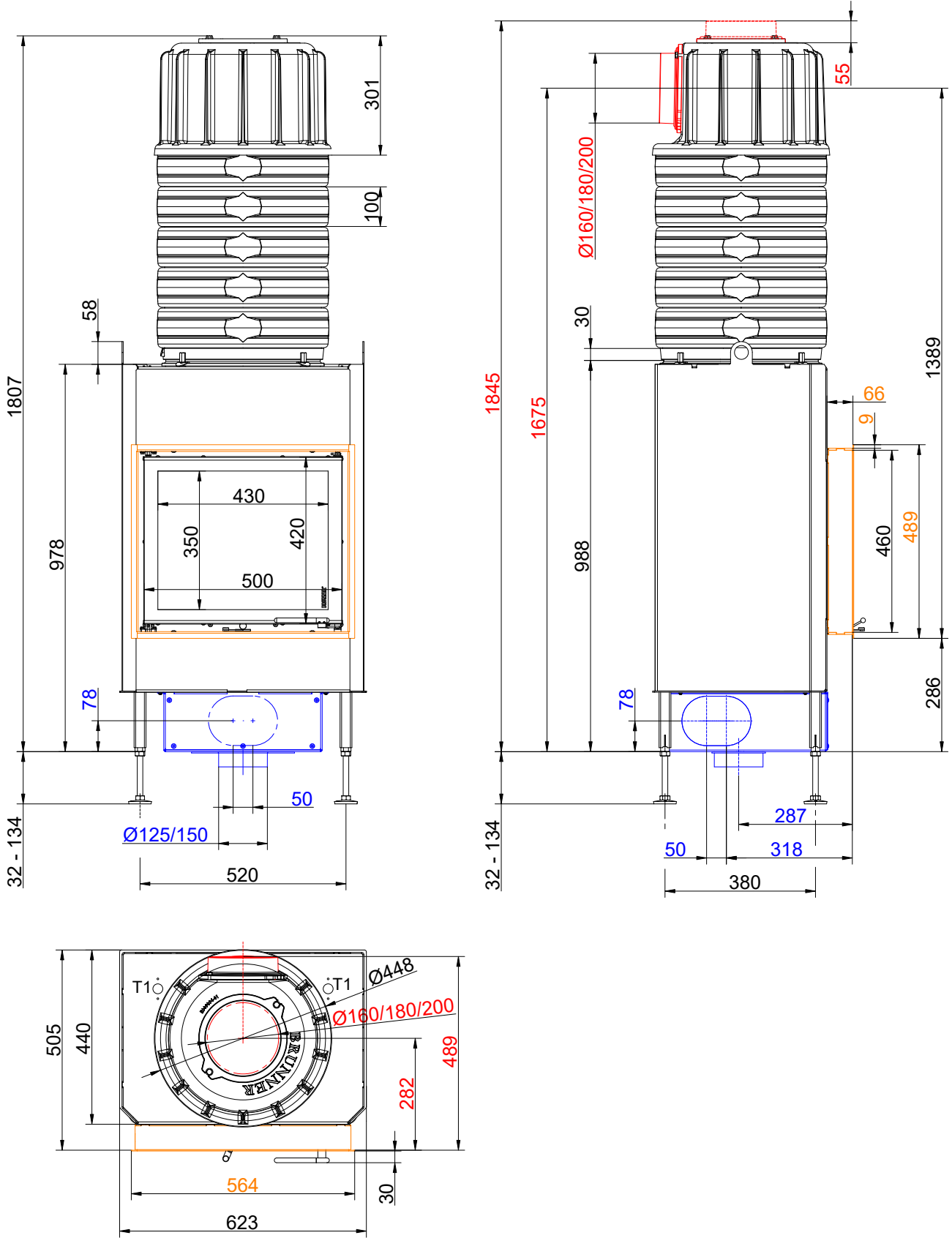

... door frame and MAS (side-opening door, DT)

Dimension sheets - BKH flat 42-50 green

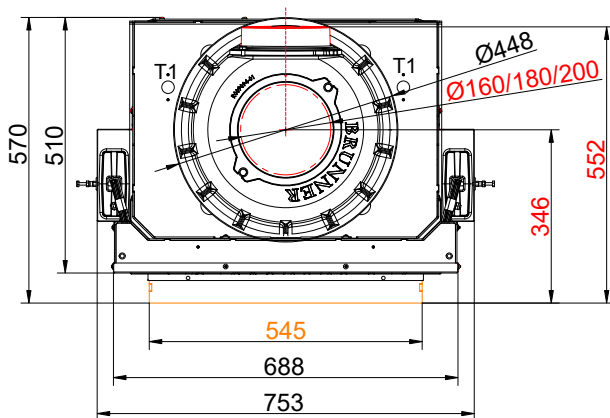
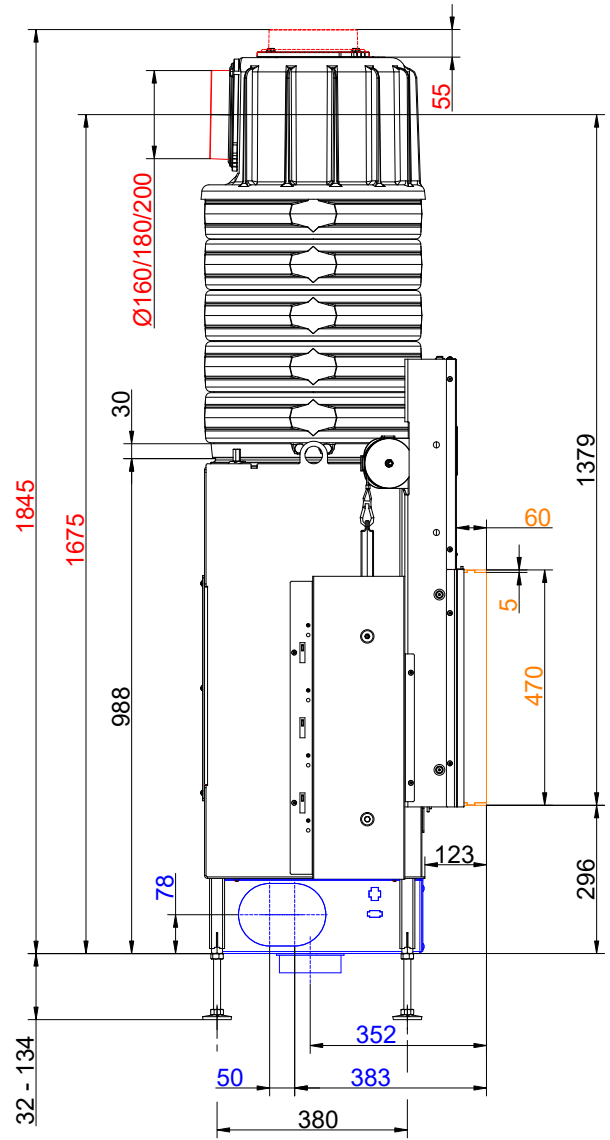
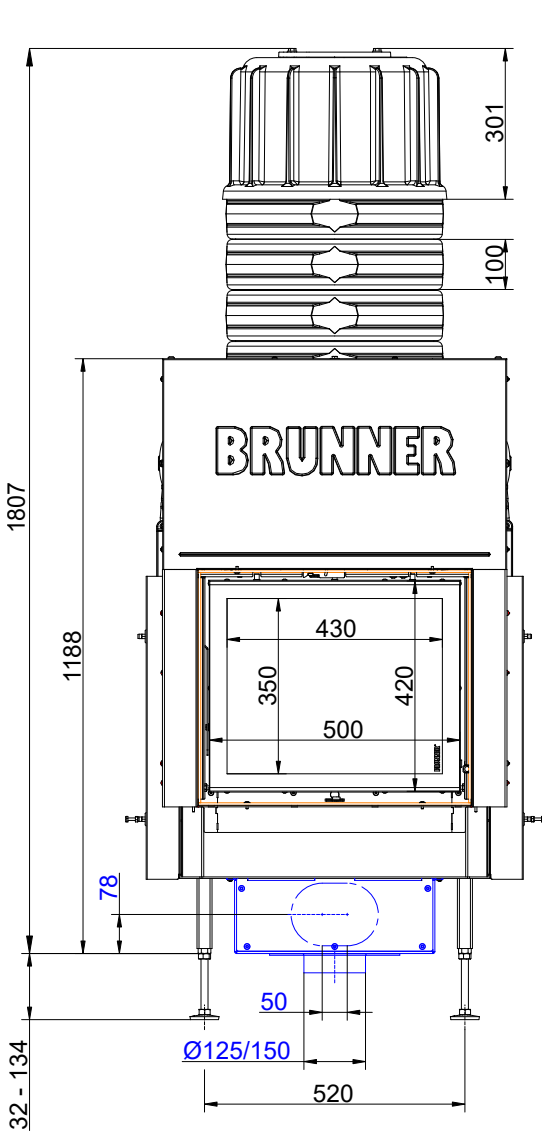

... mounting frame and MAS (lifting door, ST)

Dimension sheets - BKH flat 42-50 green

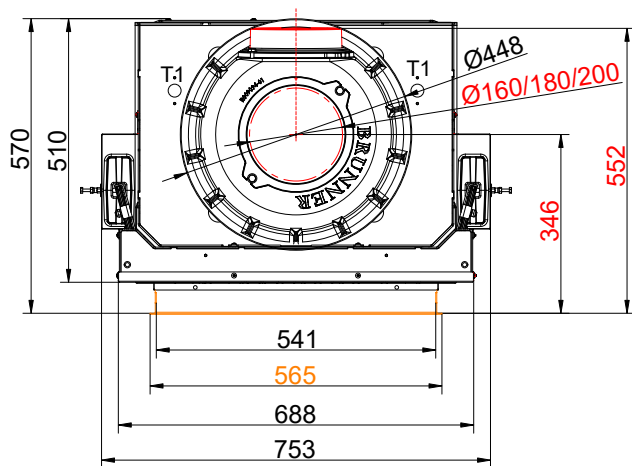
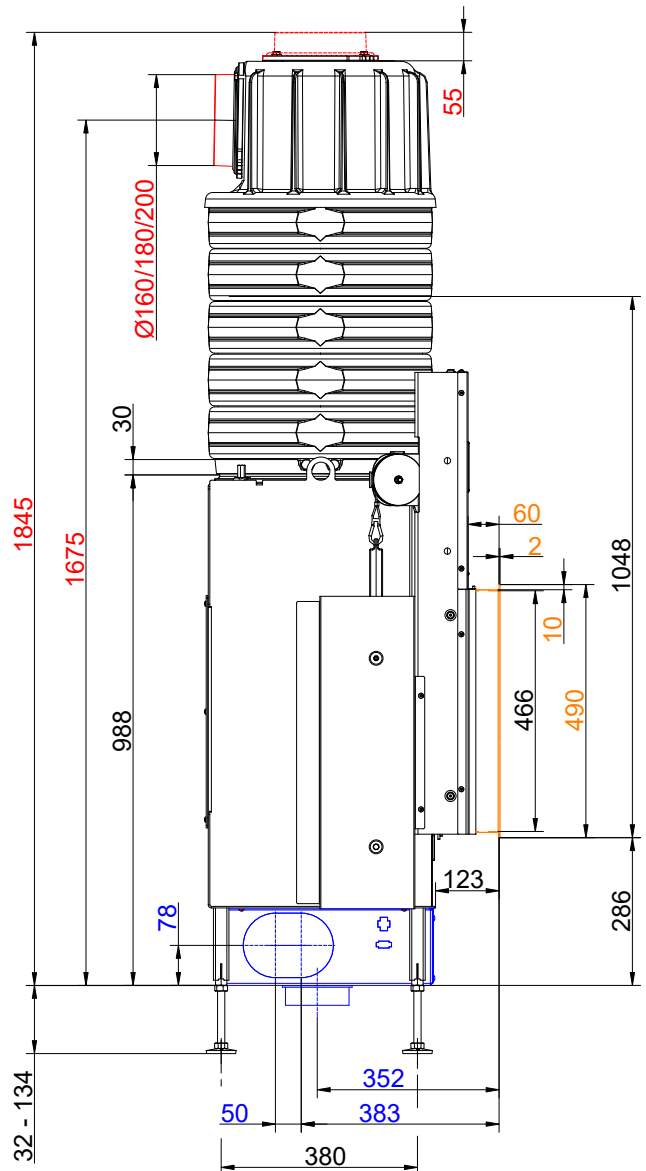
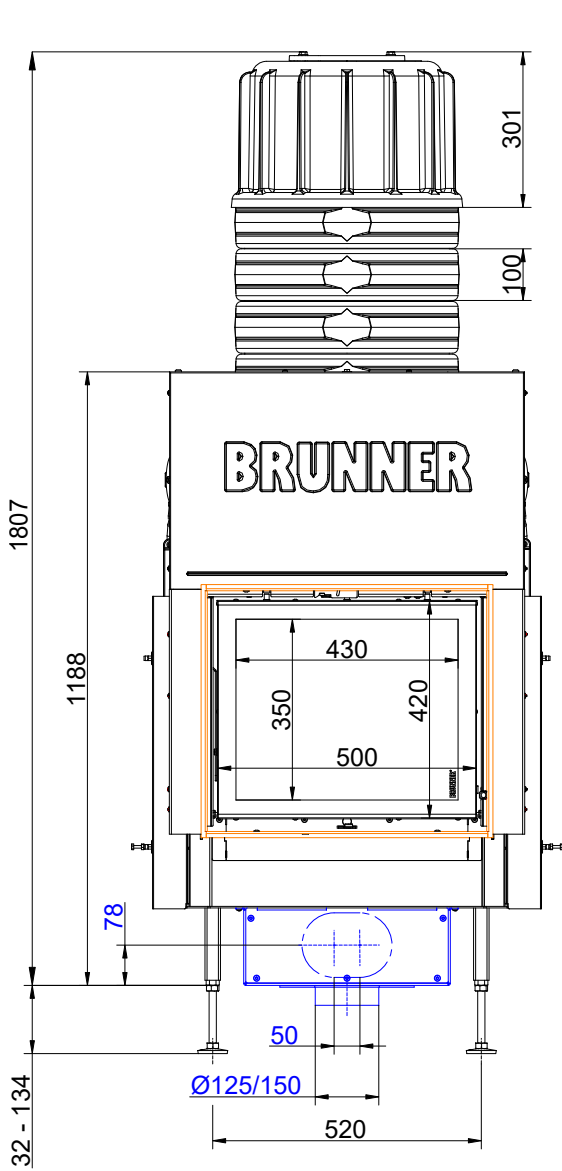

... door frame and MAS (lifting door, ST)

Dimension sheets - BKH flat 42-50 green

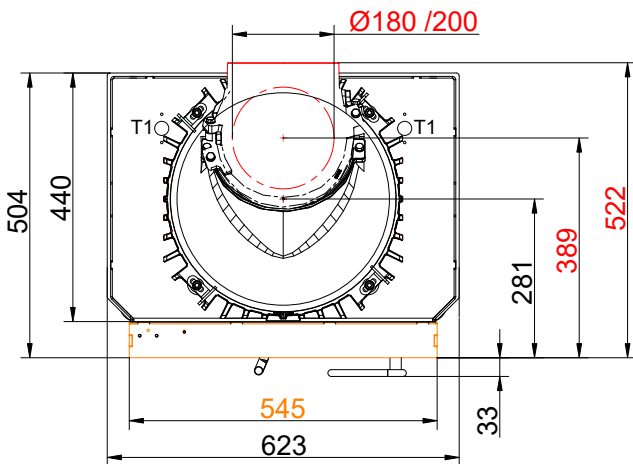
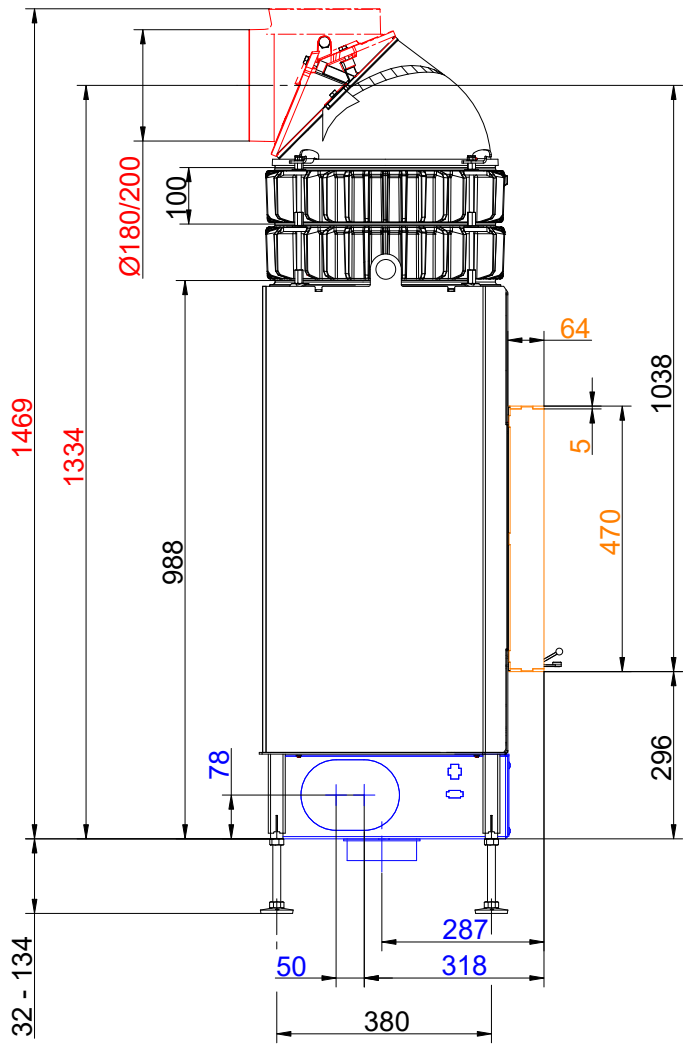
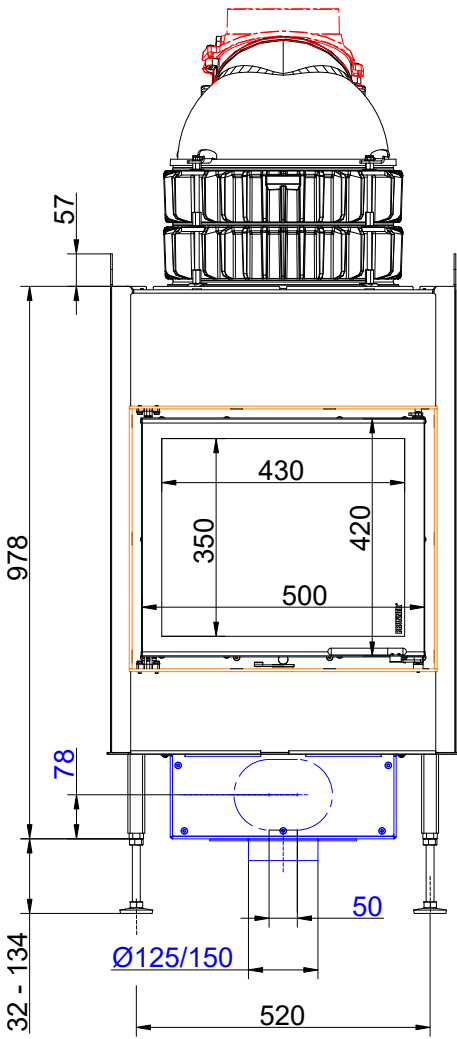

... Mounting bracket and cast iron heat exchanger rings + dome (side-opening door, DT)

Dimension sheets - BKH flat 42-50 green

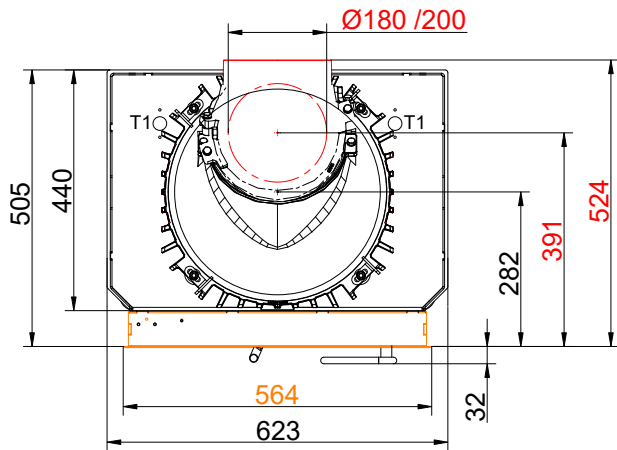
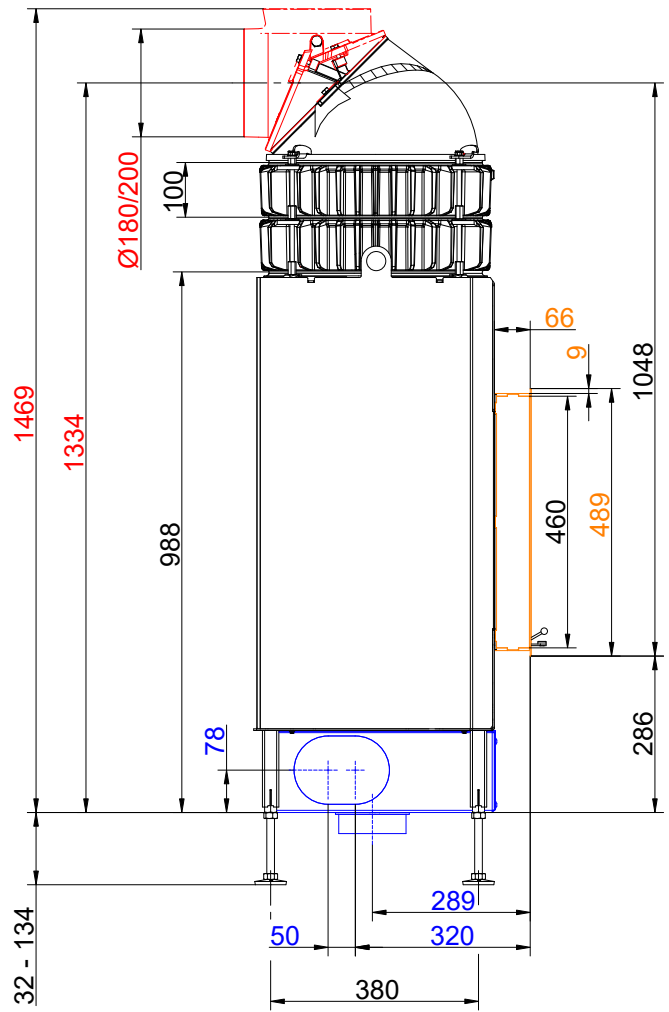
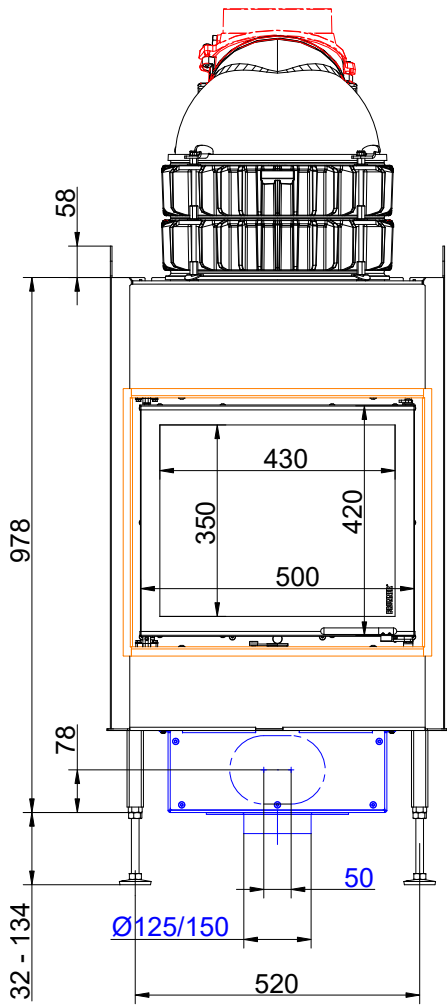

... Door frame and cast iron heat exchanger rings + dome (side-opening door, DT)

Dimension sheets - BKH flat 42-50 green

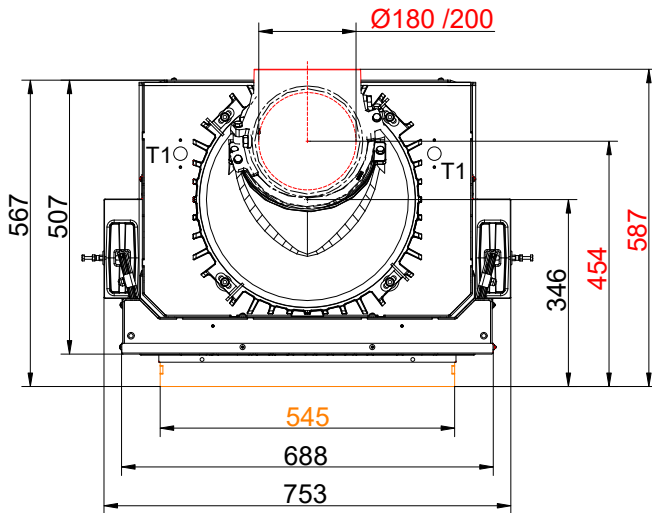
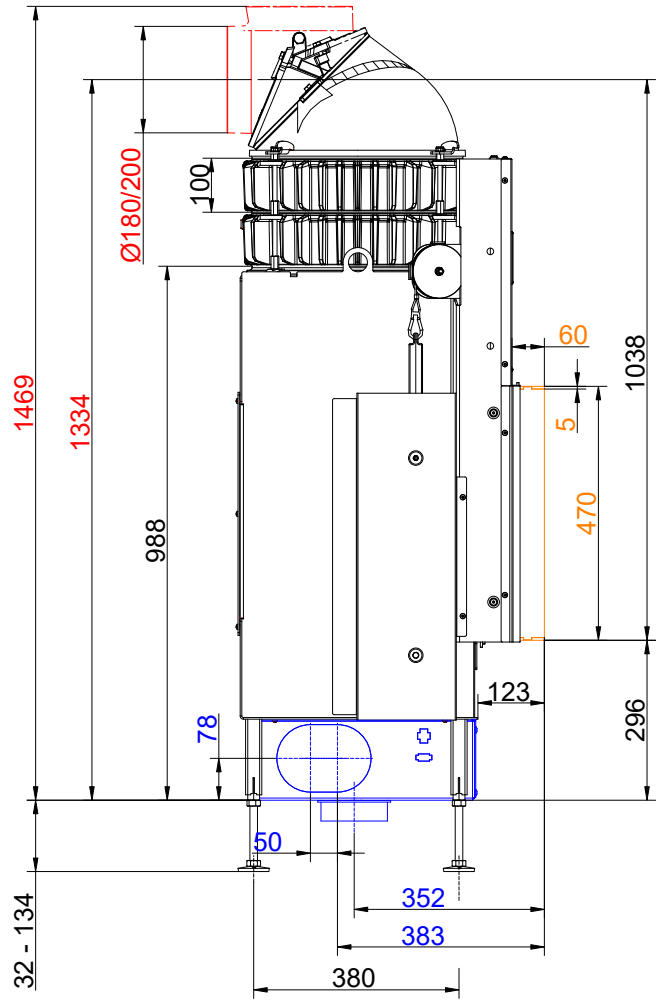
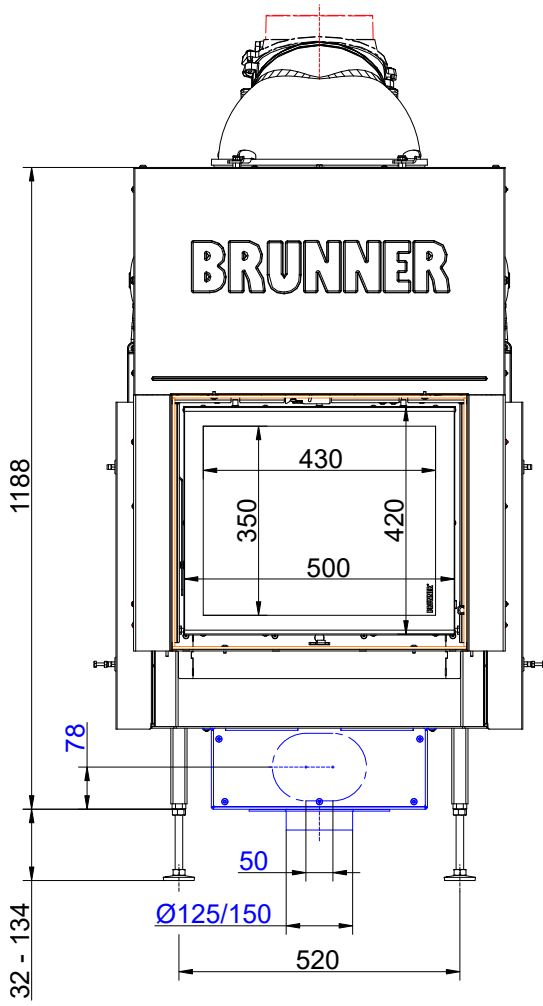

... Mounting frame and cast iron heat exchanger rings + dome (lifting door, ST)

Dimension sheets - BKH flat 42-50 green

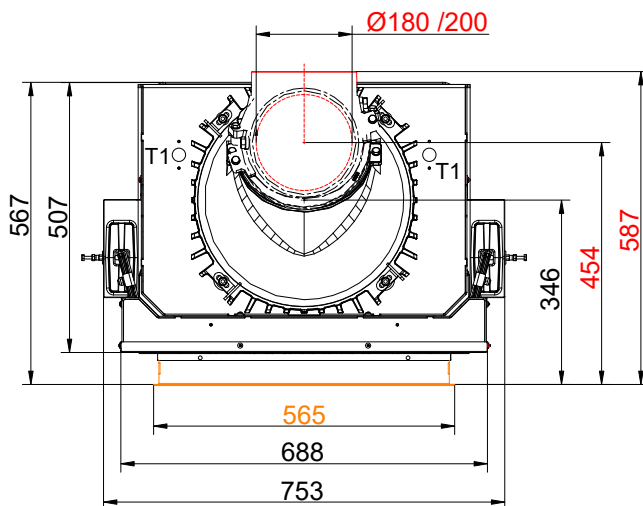
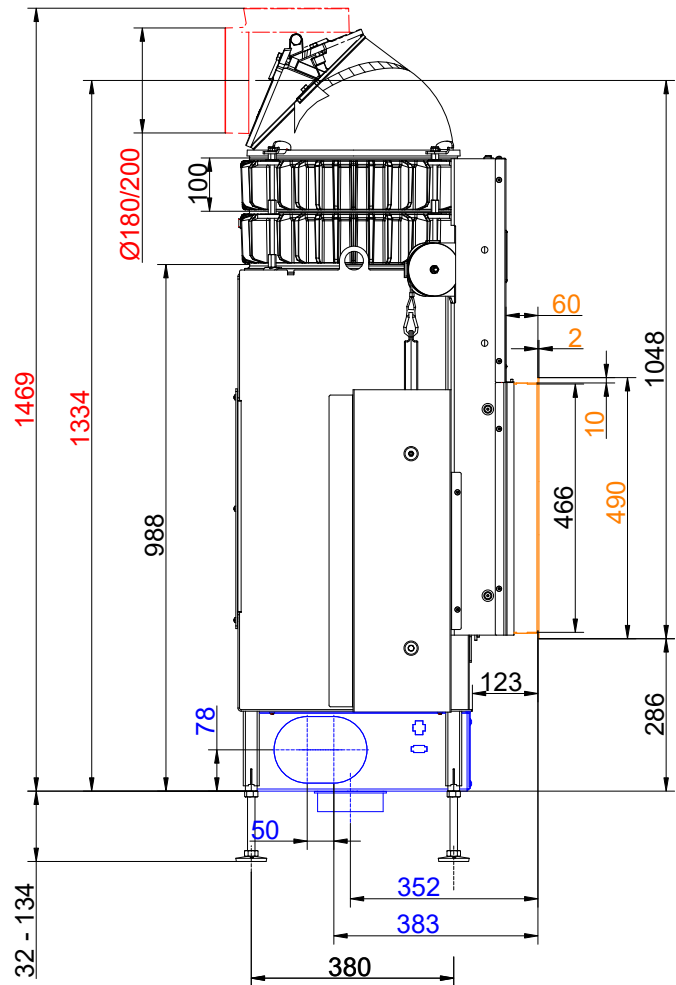
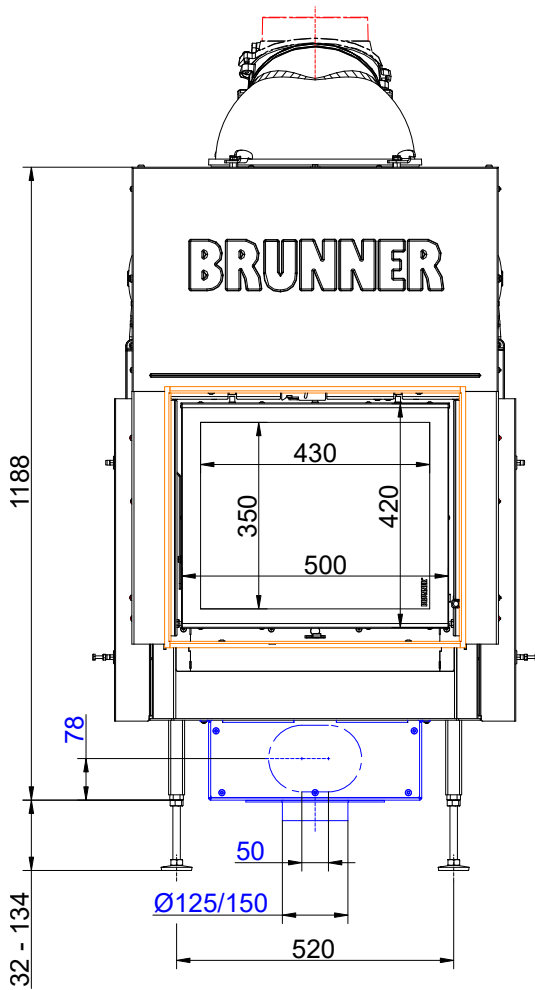

... Door frame and cast iron heat exchanger rings + dome (lifting door, ST)

We suggest for CAD planning Palette CAD. Permanent updated drawings: www.brunner.de

Frames/ flue gas outlet connection/ combustion air supply connection/ front variants/ support bearing are marked in color.

Planning and installation - BKH flat 42-50 green

Tested according to		EN 13229 W	EN 13229 WA
Values measured at		Rated power ¹⁾	Storage operation ²⁾
Data for functional demonstration			
Rated heat power	kW	8	-
Fire wood volume	kg/h	2.4	3.5
Combustion performance	kW	10	14
Flue gas mass flow	g/s	10	16
Flue gas temperature after:			
Cast iron dome	°C	220	350
2 x cast iron heat exchanger rings + dome	°C	210	260
5 x accumulation rings incl. MAS casted cover ³⁾	°C	-	260
2,0 m ceramic accumulator ⁴⁾	°C	-	180
1,4 m accumulation stones (MSS) ⁴⁾	°C	-	180
Necessary supply pressure	Pa	12	12
Fuel amount	kg	2.0	4.0
Combustion air consumption	m ³ /h	30	43
Combustion air connection Ø	mm	125	125
Heat distribution			
Insert / reheating surface	%	30 / 30	30 / 30
glass ceramic / glass ceramic coated (GKB)	%	40 / 30	40 / 30
Cross-section of gratings ⁵⁾			
exhaust warm air	cm ²	600	600
Recirculation air	cm ²	600	600
Minimal oven surface for closed construction type			
Heat dissipating surface	m ²	3.8	3.8
Minimal distances of the fireplace			
Heat protection panel for cladding, insulation layer	cm	3	3
to cladding, insulation layer	cm	5	5
to the floor (non-combustible)	cm	3	3
Minimum insulation thicknesses of substitute insulation material / reference insulation material + facing wall ⁶⁾			
with heat protection panel for mounting wall (non-combustible) ⁷⁾	cm	6 / 8	6 / 8
with heat protection panel for mounting wall (combustible) ⁷⁾	cm	12 / 13 + 10	12 / 13 + 10
to mounting wall (non-combustible)	cm	8 / 10	8 / 10
to mounting wall (combustible)	cm	18 / 20 + 10	18 / 20 + 10
to the ceiling (non-combustible)	cm	8 / 10	8 / 10
to the ceiling (combustible)	cm	22 / 25 + 10	22 / 25 + 10
to the floor (non-combustible)	cm	0 / 0	0 / 0
Minimum distances in front of the combustion chamber, glass ceramic / glass ceramic coated (GKB)			
for combustible parts	cm	≥ 120 / ≥ 80	≥ 120 / ≥ 80
Weight			
Fireplace insert + combustion chamber inner lining chamotte/cast iron	kg	104 (DT) - 142 (ST) + 71 / 87	
Meets requirement/limit values for:			
EU / Germany		Ecodesign / 1. BImSchV (Stufe 2)	

- 1) Indications to "Rated power" determined with 2 heat exchanger rings made of cast iron and Ø180 dome.
- 2) Indications to "Storage operation" for the manual execution of the reheating surface (guide values).
- 3) Damper flap recommended
- 4) Standard value or calculated functional proof required.
- 5) Air cross-sections if the specified nominal heat output is desired as the heat output.

Planning and installation - BKH flat 42-50 green

- 6) Fire safety: values determined with air cross-sections evaluated by safety testing; stove cladding is heat emitting. Insulation material data with calcium silicate (Promasil 950KS)/10 cm wall lining + reference insulation material (mineral wool according to AGI Q 132). The specifications for walls/ceilings that do not require protection and are non-combustible correspond to the specifications of TROL (Germany).
- 7) Heat protection panels (accessories) only available for selected fireplace inserts. For assembly and design of the heat protection panel see assembly instructions. Distance between mounted heat protection panel and fireplace insert: rear wall 2 cm, side wall 3 cm.