

Installation Guide

BSK 07

©2021

BRUNNER[®]
made in germany.

CONTENTS

1	Basic informations.....	3
2	General Information.....	4
3	Tolerances of thermal concrete parts.....	7
4	Parts of BSK 07.....	9
5	Sequence of assembly.....	10
6	Minimal distances.....	13
7	Heat radiation range.....	14
8	Assembly.....	14
9	Drawings and technical data.....	

1 BASIC INFORMATIONS



All instructions delivered with products must be observed. We do not accept any warranty claim or liability for damage resulting from failure to observe these installation instructions!
Improper installation can cause injury and material damage!

The installation may only be carried out by a registered specialist.

Fireplaces equipped with a water boiler must be pressure-tested after hydraulic connection to the heating system. Masonry work may follow only after this pressure test. Ulrich Brunner GmbH does not cover any costs incurred by necessary dismantling of masonry for rework at water boiler installation or replacement of the boiler.

The floor space of the room must have a suitable structure and sufficient dimensions to ensure proper functioning of the fireplace.

Please note that other installation and assembly instructions are included in other packaging units!

Dimensioning of downstream heat accumulator must be according to valid stove-setting rules.

During installation of the fireplace, all dimensions and minimal clearances of the fireplace casing must be held as specified by the manufacturer.

Fireplaces that meet the requirements of DIN EN 13240 or DIN EN 13229 and that can only be operated as intended with closed combustion chamber door or that have a self-closing firebox door are suitable for multiple occupancy.

All binding national or EU standards and local regulations for the installation of fireplaces must be observed.

All valid stove fitting rules and regulations of local construction law must be observed and followed.

Please follow the relevant regulations of your country.

When these instructions are followed and all works are done properly, this will ensure a safe, energy-saving and environmentally friendly operation of the stove. Pictures shown are not to be considered as complete representations of any kind.

Subject to technical and assortment changes.

Please notify your supplier of any damage which might have occurred during transport.

Please keep these instructions.

2 GENERAL INFORMATION

Fireplace insert

The fireplace casing sets of the Brunner System fireplace series are suitable only for the indicated fireplace inserts offered by Ulrich Brunner GmbH.

Brunner System Fireplace	Suitable fireplace insert
BSK 01	Eck-Kamin lifting door 57/52/52 with 50 mm mounting frame Eck-Kamin side-opening door 57/52/52 with door frame
BSK 02	Eck-Kamin lifting door 57/67/44 L/R with 50 mm mounting frame
BSK 03	Eck-Kamin lifting door 57/82/48 L/R with 50 mm mounting frame
BSK 04	Stil-Kamin side-opening door 62/76 with 50 mm mounting frame Stil-Kamin Tunnel 62/76 S/S as well as S/K with 50 mm mounting frame Kamin-Kessel 62/76 (support frame, art. no. N002072 necessary)
BSK 05.1	Panorama-Kamin 57/40/60/40 with fire table
BSK 06	Architektur-Kamin lifting door 45/101 with 50 mm mounting frame Architektur-Kamin Tunnel 45/101 S/S as well as S/K with 50 mm mounting frame Kamin-Kessel Tunnel 45/101 S/S as well as S/K with 50mm mounting frame Kamin-Kessel 45/101 and Kamin-Kessel Tunnel 45/101 (For the horizontal outlet rear or left/right, "Smoke pipe branch BSK", art.no. I019490 is necessary.)
BSK 07	Architektur-Kamin 38/86/36 corner with 50 mm mounting frame
BSK 08	Kompakt Kamin 51/67 lifting door, flat Kompakt Kamin 51/67 side-opening door, flat
BSK 09	Eck-Kamin 42/42/42 side-opening door with frame
BSK 10	Panorama-Kamin 42/42/42/42 with firetable
BSK 11	Panorama-Kamin 70/25/40/25 with firetable
BSK 12	Eck-Kamin 42/57/30 Kamin-Kessel Eck 42/57/30
BSK 13	Panorama-Kamin 51/66/50/66 with firetable and support frame

The above indicated combinations of BSK casing set and fireplace inserts are tested according to EN 13229. As a result, there are certain distances and insulation thickness data to be followed and applied.

The Brunner System Fireplace components fulfil the requirements of exposed concrete class SB2.

Floor

On flammable floors, the fireplace must be placed on a plate made of non-flammable material. This plate must be at least 500 mm long in front and 300 mm wide on both sides of the fireplace.

The base plate of fireplace casing must be carefully set to level; please pay attention, that it lies on the floor over the entire surface. It is recommended to use the wall as reference and set the base plate at 90 degrees. The completely set fireplace cannot be moved or turned afterwards.

Acrylic adhesive

Used pointwise to stick elements together and to fill the gaps.

Painting

24 hours after assembly you can paint the fireplace casing. Plastered walls must be previously sanded with fine abrasive paper.

Hairline cracks

Joints between the elements of fireplace casing and the between the house wall and the fireplace casing can tend to the formation of small cracks. This is normal and no cause for concern. Small cracks can be removed with the revision set (Art.Nr.: 900300).

After 24 hours the joint can be painted over.

Bigger cracks

Transportation damage must be reported immediately to the shipping company. Replacement parts can be order at Ulrich Brunner GmbH.

In the case of bigger defects that cannot the repaired with the revision set (Art.Nr.: 900300), it is possible to request for exchange at Ulrich Brunner GmbH as part of your warranty.

Replacement requests:

When ordering replacement parts it is necessary to mark the damaged parts on the attached packing list and make a picture of the damage. Then, the printed picture and packing list should be sent back to Ulrich Brunner GmbH. The replacement part will be sent as soon as possible.

Fireplace casing with concrete look

The fireplace casings with concrete look, despite the best possible care during manufacturing and shipping, can show slight irregularities like air inclusions, small cracks or unclean edges. This corresponds entirely to the concrete look and does not constitute a reason for a claim. Cracked or significantly damaged elements will be replace as part of your products' warranty.

Built-in components

If any additional components like electronics (EOS) or similar are installed inside the fireplace casing, the max. allowed ambient temperature must be followed. Electronics must be installed in such a way to provide for rear ventilation.

All safety distances are minimal required distances.

Subject to errors and changes!



Please follow the separate installation instructions for the fireplace insert.

3 TOLERANCES OF THERMAL CONCRETE PARTS

The following tolerances are valid for all parts of our system fireplace/stove casings. Except where otherwise indicated, all data refer to the nominal dimensions, as found in dimensional drawings.

Length Tolerances

For each part, the indicated tolerances apply.

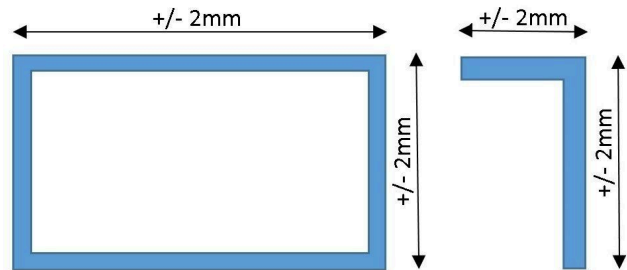

Height Tolerances

For each part, the indicated tolerances apply.



Tolerances of Flatness

For parts with nominal dimensions up to 950 mm, a tolerance of +/- 2.5 mm applies. Above this dimension, a tolerance of +/- 3 mm applies.

These tolerances apply also for the base support and top cover parts. The leveling board (R) must be placed in parallel to the basic body!

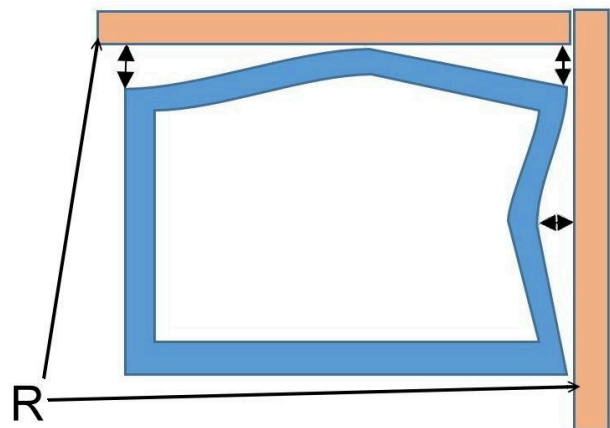

Illustration 1: Leveling boards placed correctly

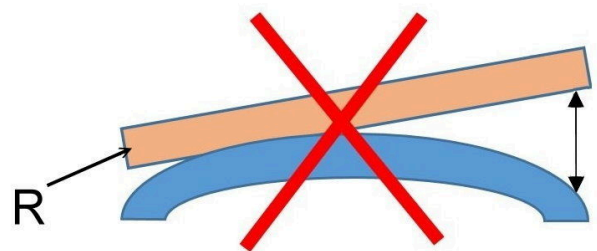
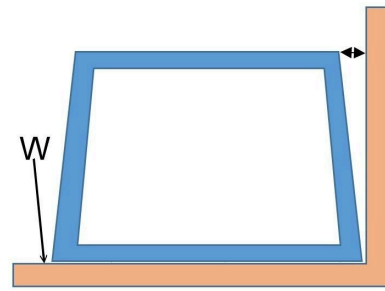

Illustration 2: Incorrectly placed leveling board

Tolerances of Angle

In order to determine the deviations of angles, place the square measuring tool along the long edge!

For nominal dimensions up to 600 mm, a tolerance of 0.28%, i.e. 1.7 mm applies. For nominal dimensions up to 900 mm, a tolerance of 0.30%, i.e. 2.4 mm applies.



Roundness

Up to a nominal diameter of 650 mm, a tolerance of 0.25%, i.e. 1.62 mm applies. For diameters above this value, a tolerance of 0.28%, i.e. 2.38 mm applies.

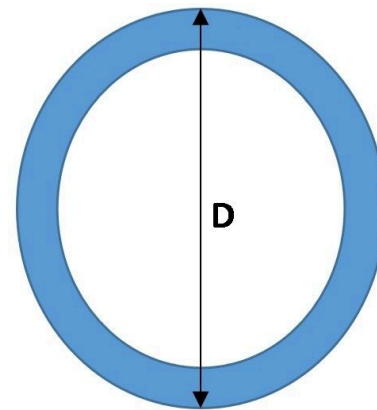

Wall thicknesses

For wall thicknesses, a tolerance of 3.5% applies.

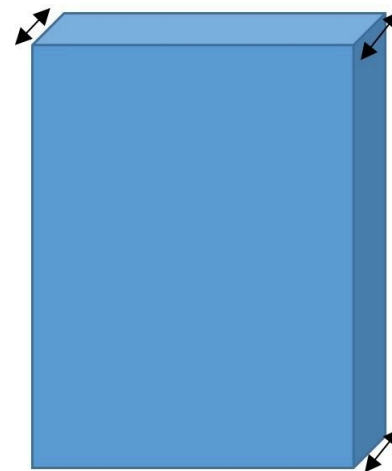

The overall appearance with color shade differences being present or not can be assessed in general only after a longer period of time (several weeks in some cases). The uniformity of color should be assessed from a typical viewing distance.

4 PARTS OF BSK 07

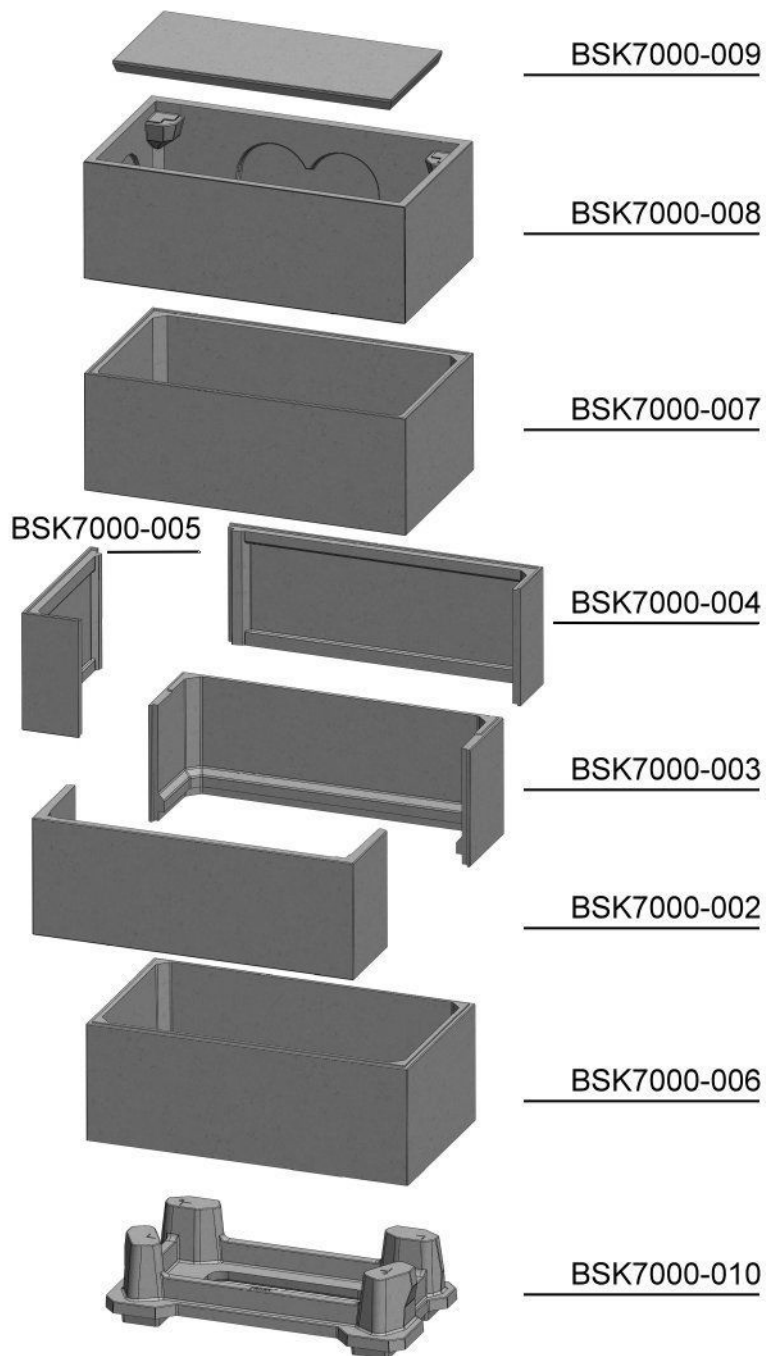

The optional available support bearing (Art..Nr.: N002082) for the higher installation is not illustrated. When installing the lower variant, the item BSK7000-006 is not needed.

5 SEQUENCE OF ASSEMBLY

Option with fireplace at 40 cm height

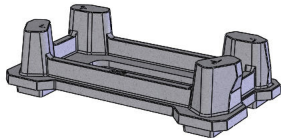

Illustration 3: Align the bottom plate

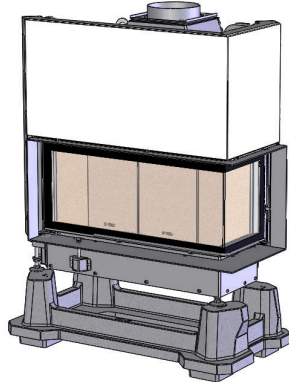

Illustration 4: Place the Corner fire-plate onto the bottom plate and align it

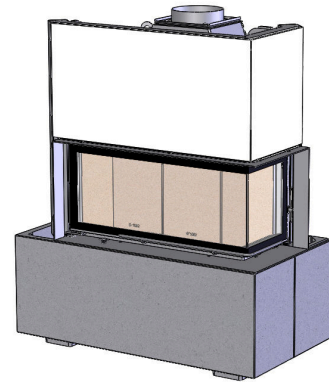

Illustration 5: Place the lower segments onto the bottom plate

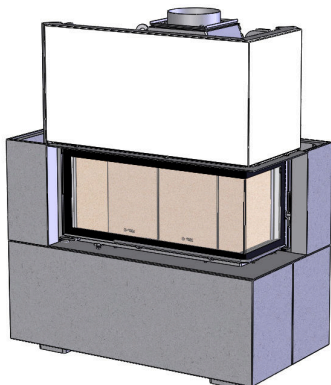

Illustration 6: Set up the components of els (if ordered) and set up the third the second ring

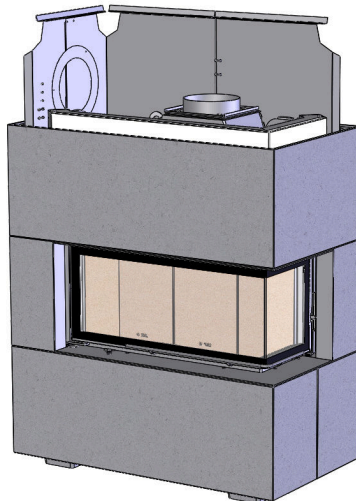

Illustration 7: Insert the radiation pan-

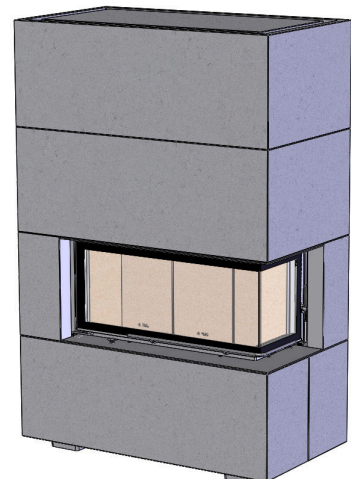

Illustration 8: Place the 4th ring and set up the cover plate

Option with fireplace at 80 cm height

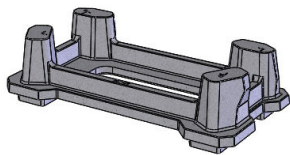

Illustration 9: Align the bottom plate

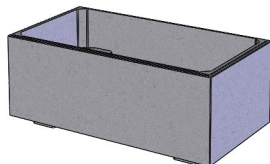

Illustration 10: Place the first ring on the bottom plate

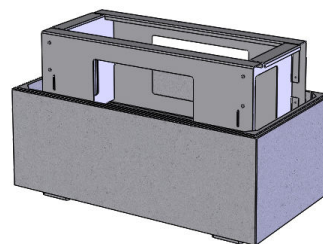

Illustration 11: Place the support bearing onto the bottom plate and align it

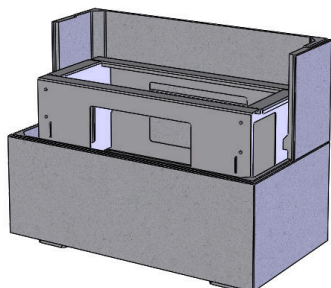

Illustration 12: Set up the back wall element

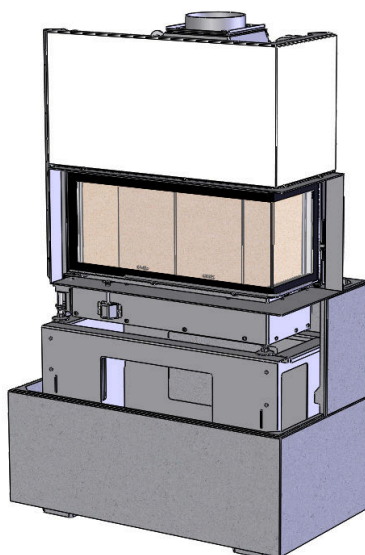

Illustration 13: Put the Architecture corner fireplace on top of the support bearing

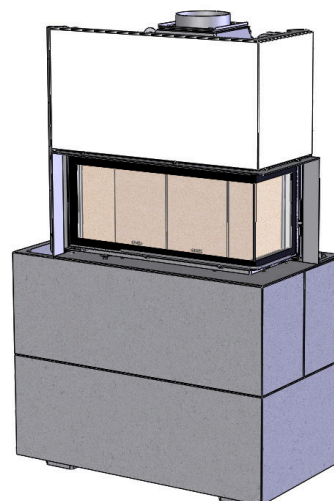

Illustration 14: Set up the front element

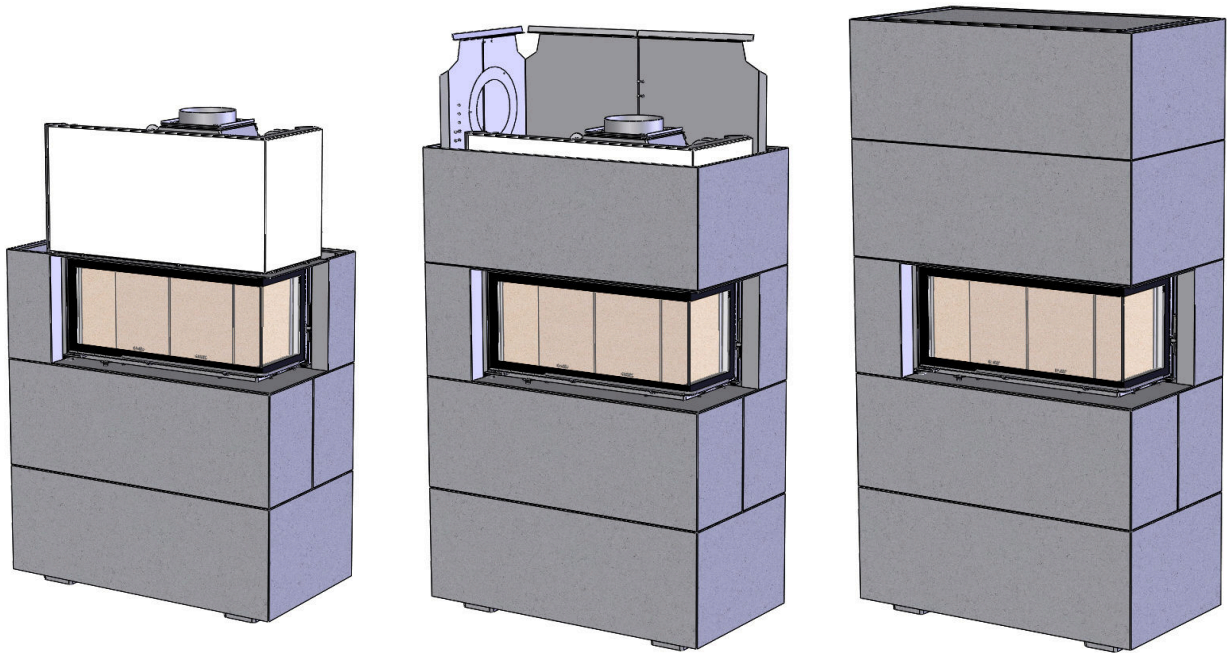

Illustration 15: Lift the fireplace enclosure over the fireplace and apply it on the lower elements

Illustration 16: Insert the radiation panels (if ordered) and place the 4th ring

Illustration 17: Set up the 5th ring and the cover plate

6 MINIMAL DISTANCES

Minimal distances to adjacent walls

Depending on wall type (flammable or non-flammable wall), the minimal distances are different. With installed heat protection screen it is possible to minimize the distance to adjacent wall.

Without heat protection screen:

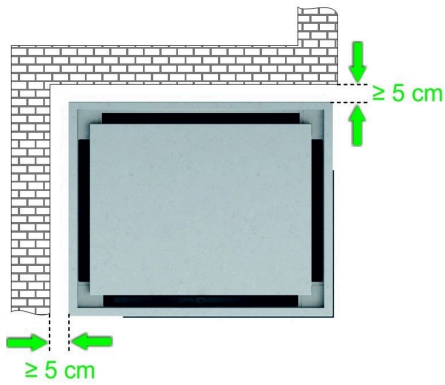

With installed heat protection screens:

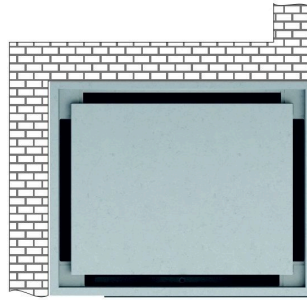

Other walls:

- ▶ aerated concrete
- ▶ ceramic bricks
- ▶ sand-lime bricks
- ▶ mineral building materials with wall thicknesses > 10 cm

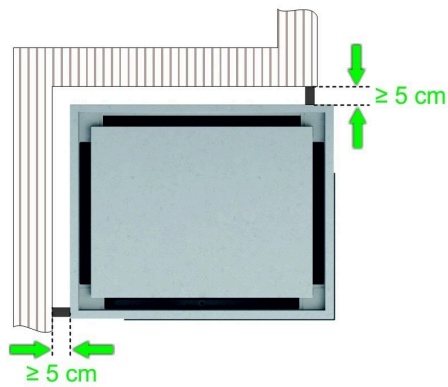
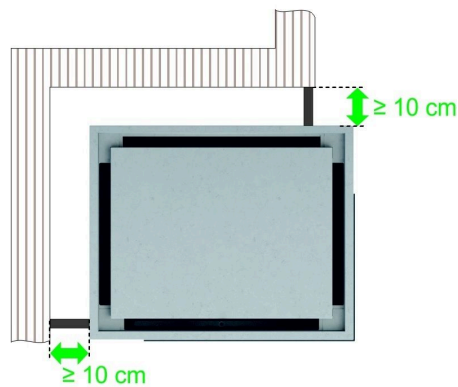

Walls requiring protection:

- ▶ flammable walls and wall structures
- ▶ load-bearing reinforced concrete walls
- ▶ other walls up to 10 cm thickness
- ▶ walls with built-in furniture behind them (heat accumulation)

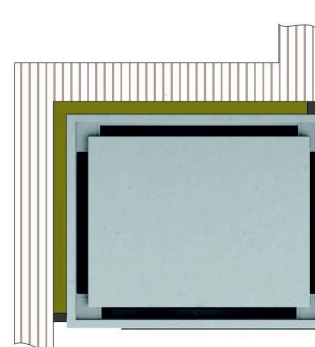
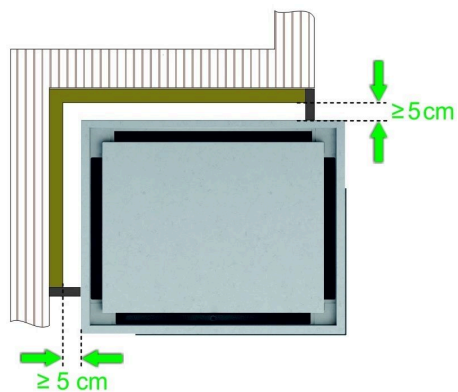

Walls requiring protection with 10 cm brick lining or alternative insulation

Thermal concrete slabs (assembled by craftsman, with exposed joints)



Non-flammable wall, not requiring protection (other walls)



Flammable walls requiring protection



Brick lining or equivalent alternative insulation material, insulating panel

7 HEAT RADIATION RANGE

Within the range of heat radiation through the fireplace door (glass pane) there must be a minimal distance to all flammable parts (e.g. built-in furniture, fixtures) of at least 80 cm.

Outside the heat radiation range, any flammable fixtures cannot be exposed to temperatures above 85°C. Large-dimensioned parts from flammable materials or built-in furniture must have a clearance of at least 5 cm to external fireplace cladding. In this clearance, the room air must be able to circulate without any obstacles.

In general, parts of external fireplace cladding are allowed to be installed without any clearances, if such parts are not exposed to temperatures above 85°C under any circumstances.

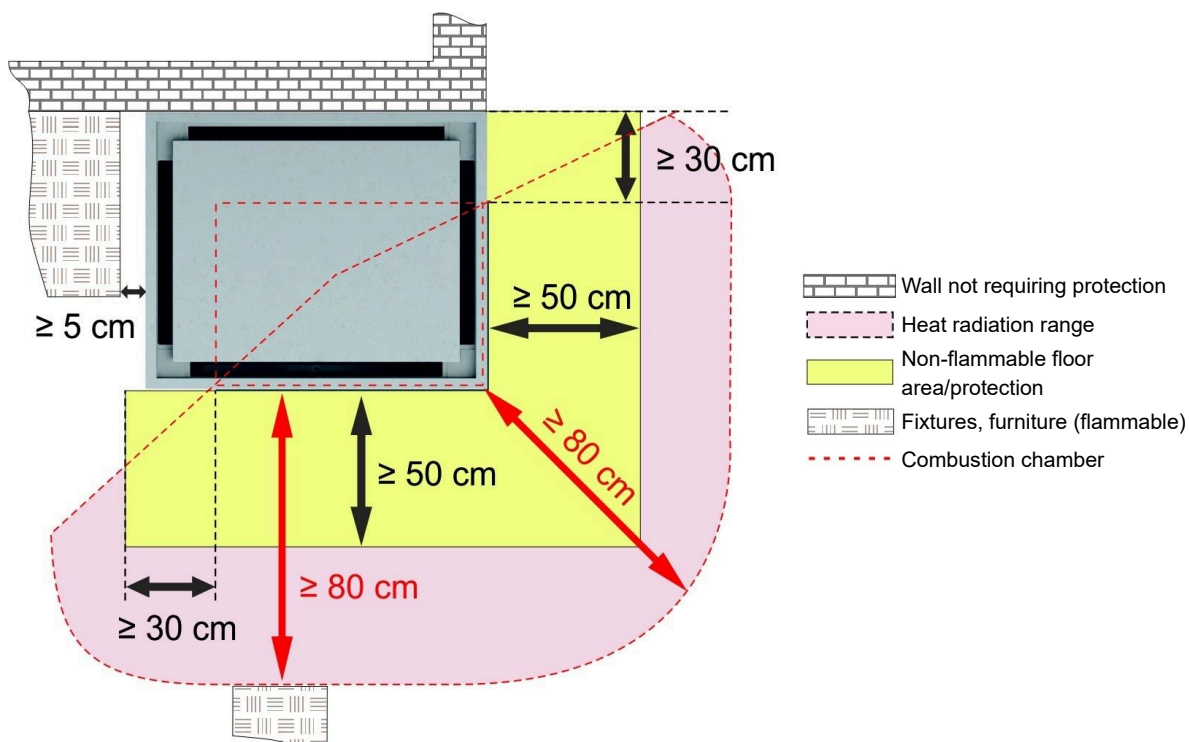

8 ASSEMBLY

Sequence of assembly

For sequence of assembly, please follow the instructions in chapter 'Sequence of assembly'. It shows each and every step of assembly.

Always keep to the specified order!

The single elements must be examined closely before installation to ensure correct position. Don't forget the pointwise bonding of elements with acrylic adhesive.

The assembly sequence of protective panels is only an example and can be different in various cases.

Fireplace insert

To compensate for the different thermal expansions between the fireplace insert and casing, a gap of ca. 2-3 mm must be left around the doors.



If the fireplace casing is in direct contact with the fireplace insert, it leads to damage of the fireplace casings, which are not covered by our warranty.



The mounting frame must have an overlap of about 4 mm.

Breakthroughs and breakouts

Breakthroughs for smoke pipe connection, air gratings or other components within the fireplace casing must be created on site. These are to be made with extreme caution to prevent breakage of the components.

Damage caused by improper work is not covered by the warranty.

The safest way to create the breakthroughs is using a jigsaw.

Setting of the ring elements

The ring elements of the fireplace casings must be lifted over the fireplace insert previously set on the base plate. To avoid damages during setting, it is recommended to place the elements on pieces of wood, and then set down the ring element carefully after pulling out the wood pieces.

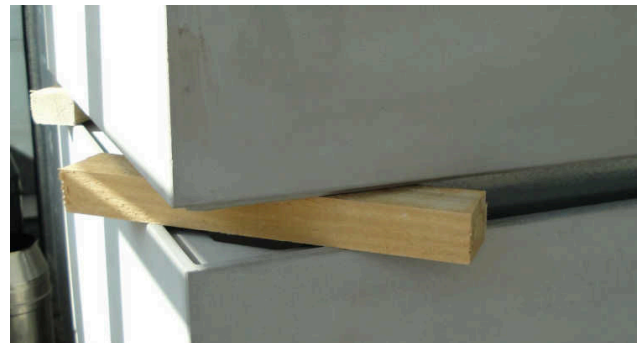

Illustration 18: Wood pieces as supports

Plastering

Before plastering the fireplace casing, the fireplace should have been heated once. As a result, the fireplace casing can expand and break down the biggest stresses. This prevents or reduces subsequent cracks in the surface of the plastered fireplace.

The surface of the fireplace casing must be cleaned with a damp cloth. A pre-wetting of the surface is not required.

Keep processing temperature above 5°C (41 deg. Fahrenheit).

To avoid stress cracks as much as possible, a fiberglass mesh is applied with adhesive plaster (optional) Brunner Universal (Art.Nr.: 900384) or Brunner Spezial (Art.Nr.: 900284) on the fireplace casing.

The actual plaster layer is then drawn with adhesive plaster over this layer.



Please note the processing instructions for the adhesive plaster.

Excerpt from the processing instructions: Mix dry mass before removal of processing volumes in a clean container. Set small quantities in a mason pan with a spatula or trowel with clean tap water into application-specific consistency and process quickly; for large-area coating, stir with a mortar agitator in low speed intensively, allow to soak, stir again and then process quickly.

Heat protective panels

Heat protective panels are always necessary, when the BSK is set directly adjacent to a wall, i.e. if the minimal distance (see 'Technical Data') cannot or should not be held there. The heat protective panels are necessary only on this part of the BSK interior, that is adjacent to a wall.



The assembly steps of heat protective panels shown in assembly sequence is only an example.

With limited ceiling height, the heat protective panels may not be inserted from the top into the BSK fireplace casing. In this case, the heat protective panels must be inserted before the upper rings are set.

Please follow the heat protective panels' enclosed instructions.

Air supply (combustion and convection air)

Before the lower elements are set, it is necessary to provide for the required air supply. The necessary dimensions can be found in chapter 'Technical Data'.

The hot air outlet is provided by the free cross sections in the ceiling region. If they are blocked, it is necessary to prepare a sufficient hot air outlet (see section 'Technical Data') on site. **Risk of overheating!**

The openings for air supply and hot air outlets with the specified cross sections are required, even if the fireplace is provided with external air supply.

For procedure on how to create air intake opening, please refer to section 'Breakthroughs and outbreaks'.



The stove cannot be used without sufficient air intake or hot air outlets.

Please observe the installation instructions provided with the fireplace/stove insert.

For the construction of BSK 07 with the fireplace at 40 cm height the lower ring is not required. Please **do not** send it return!

For the construction of BSK 07 with the fireplace at the height of 80 cm the supporting bearing of AK Eck 38/86/36 in connection with BSK 07 (high construction version) is required.

If the flue outlet is desired on side, back or on the top center of BSK 07, the flue gas adapter 38/86/36 for horizontal exit artno : BSK7000 -129 is required.

Dimension sheets - BSK 07 with Architektur-Eck 38/86/36

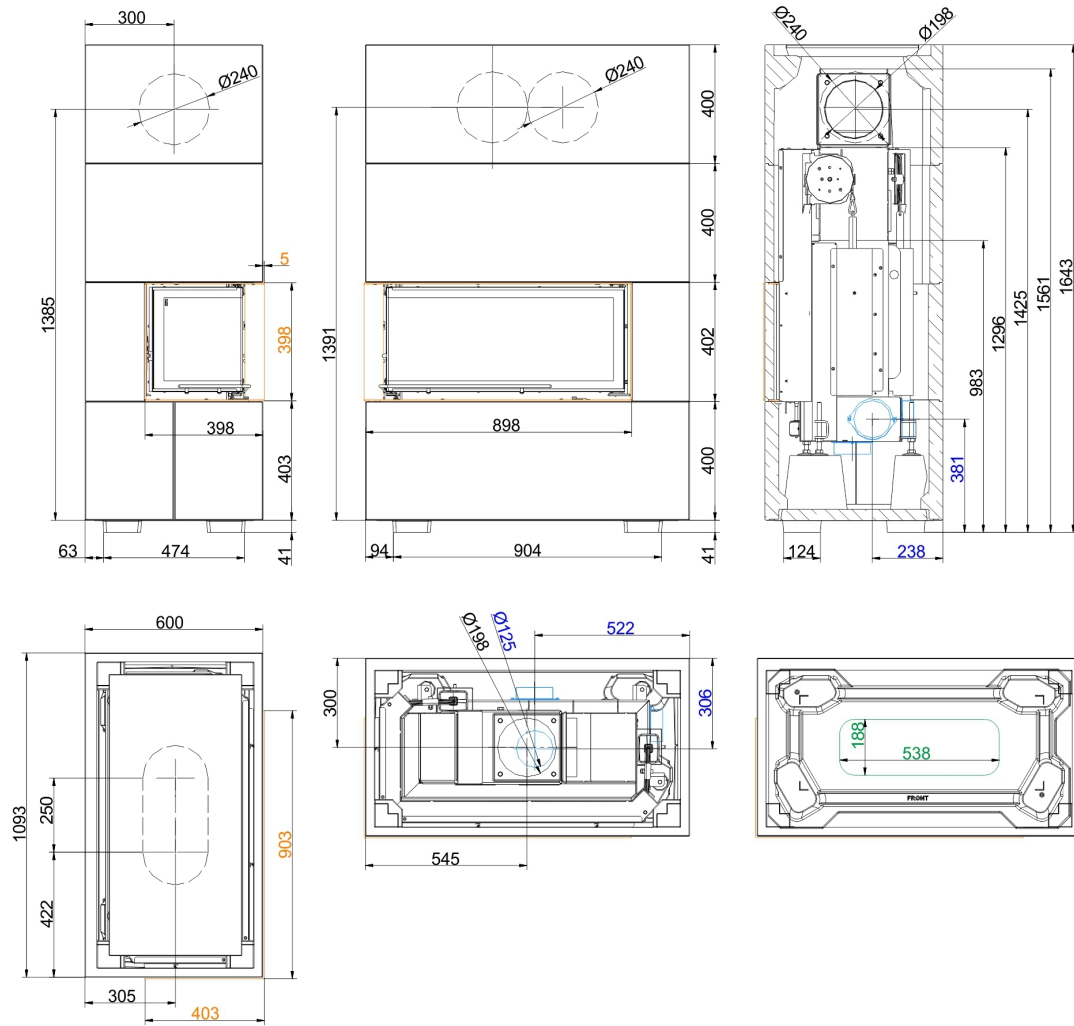

... left

Dimension sheets - BSK 07 with Architektur-Eck 38/86/36

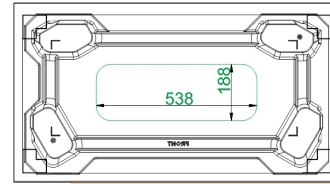
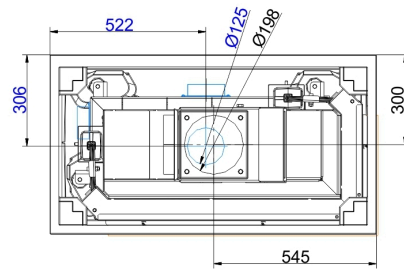
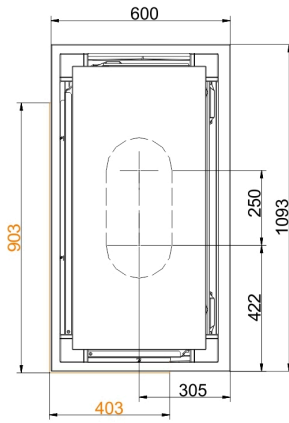
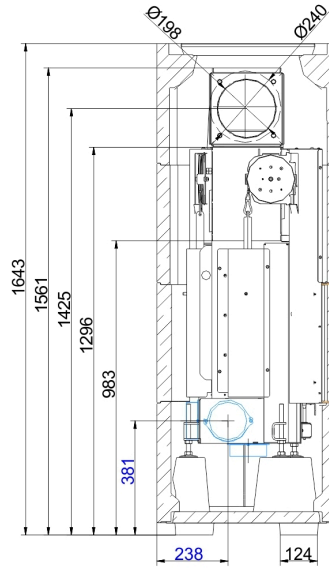
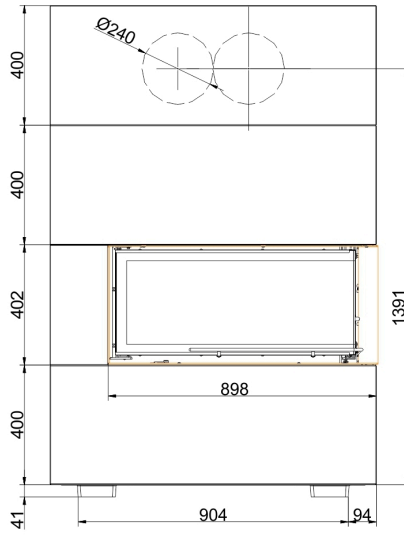
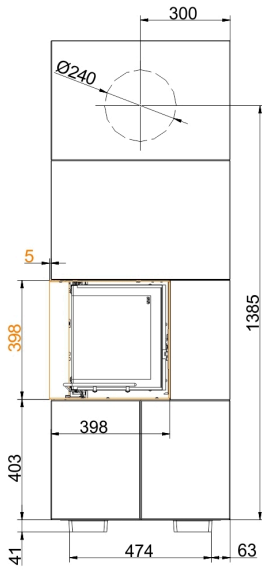

... right

Dimension sheets - BSK 07 with Architektur-Eck 38/86/36

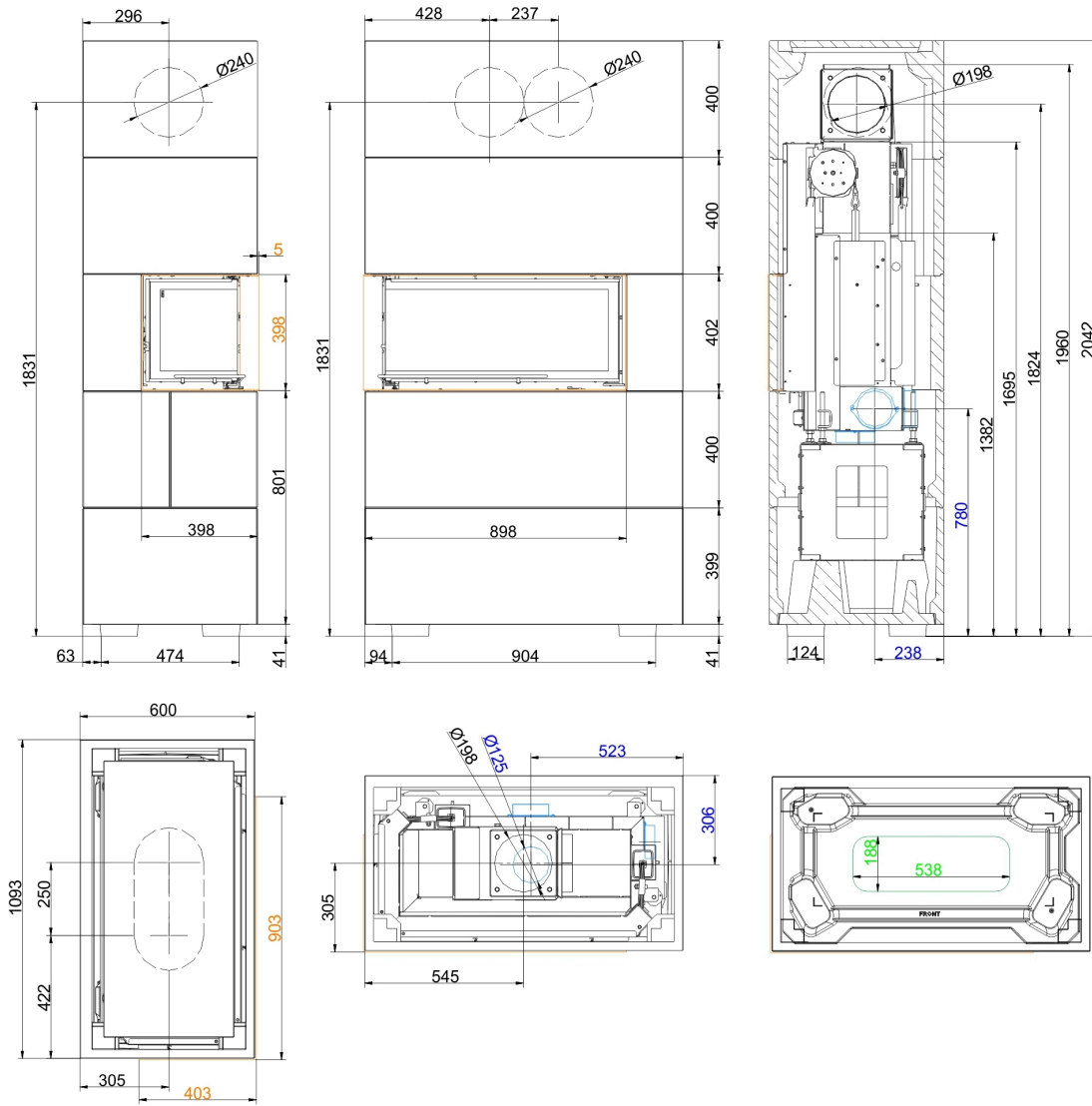

... left high

Dimension sheets - BSK 07 with Architektur-Eck 38/86/36

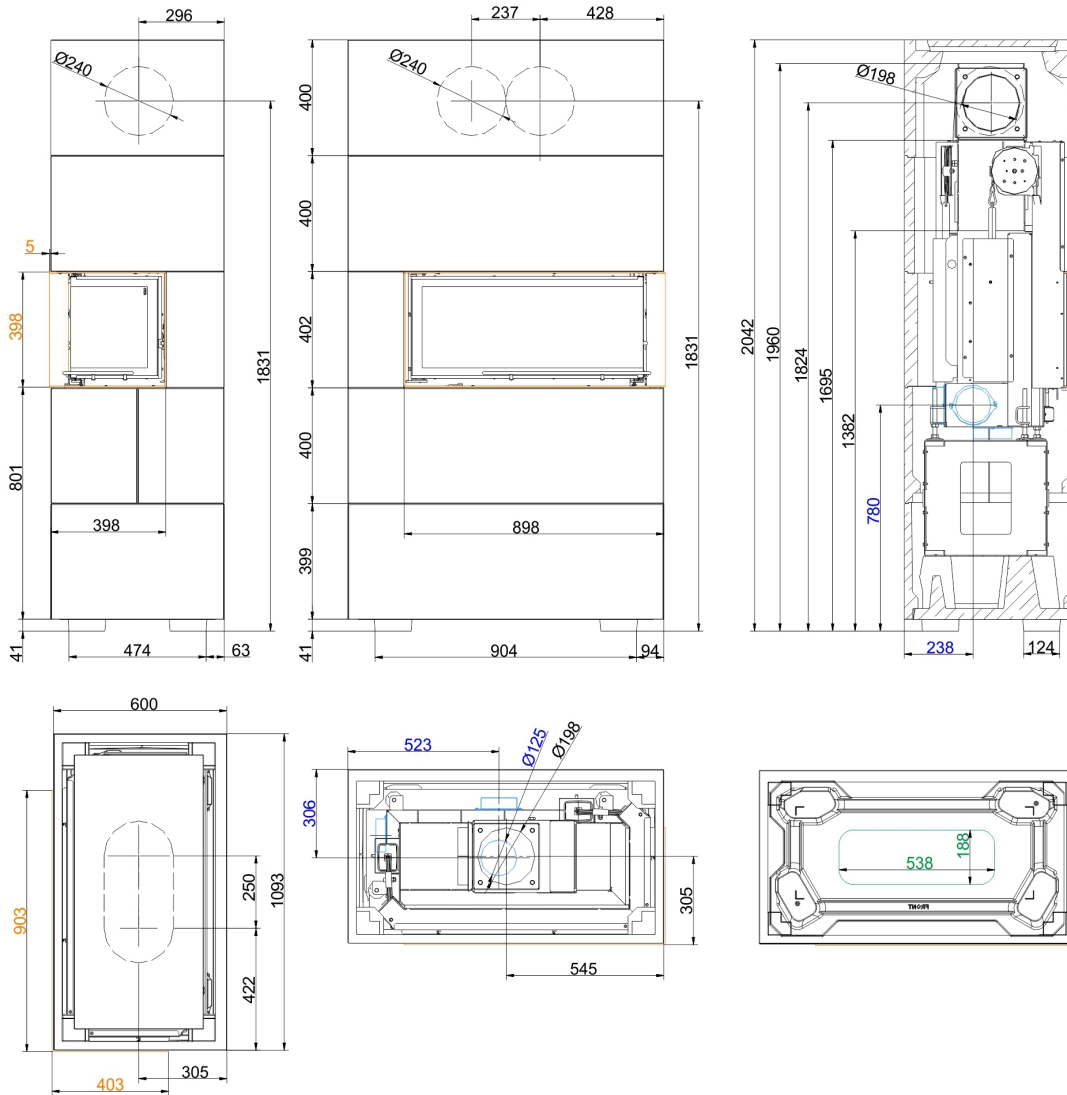

... right high

We suggest for CAD planning Palette CAD. Permanent updated drawings: www.brunner.de
 Frames/ flue gas outlet connection/ combustion air supply connection/ front variants/ support bearing are marked in color.

Planning and installation - BSK 07 with Architektur-Eck 38/86/36

Tested according to		EN 13229
Data for functional demonstration		
Rated heat power	kW	10
Fire wood volume	kg/h	3.1
Flue gas mass flow	g/s	11
Flue gas temperature	°C	220
Necessary supply pressure ¹⁾	Pa	12
Combustion air consumption	m ³ /h	30
Combustion air connection Ø	mm	125
Cladding components		
Foot print (W x D)	mm	1093 x 600
Overall height	mm	1643 / 2042
Height of extension ring	mm	400
Minimal distances		
to mounting wall	cm	5
to mounting wall with heat protection panels	cm	0
to combustible mounting wall	cm	10
to combustible mounting wall with heat protection panels	cm	5
from top of fireplace to ceiling	cm	50
Cross-section of gratings ²⁾		
Convection air	cm ²	985
Supply air	cm ²	900
Weight		
Total weight	kg	564 / 647
Meets requirement/limit values for:		
Germany/ Austria / Switzerland / Norway		1.BImSchV (Stufe 2) / - / LRV / NS 3059

1) Damper flap recommended

2) Existing convection air openings. If the construction differs from the supplied system kit (e.g. construction up to the ceiling or closed construction), the information in the data sheet is decisive for carrying out the cross section of the convection air openings.

Product data sheet according to (EU) 2015/1186:

Supplier's name or trademark	Ulrich Brunner GmbH
Model identifier:	Architektur-Eck 38-86-36
Energy efficiency class:	A
Direct heat output:	10,0 kW
Indirect heat output:	N.A. kW
Energy efficiency index:	107
Fuel energy efficiency (at nominal heat output):	81,0 %
Fuel energy efficiency (at minimum load):	N.A. %
Special precautions: see supplied product documentation	

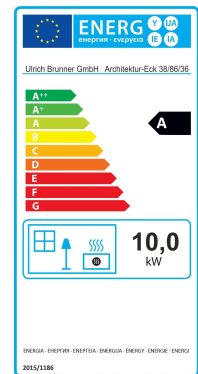

Ulrich Brunner GmbH
Zellhuber Ring 17-18
D-84307 Eggenfelden
Tel.: +49 (0) 8721/771-0 / Fax: +49 (0) 8721/771-100
Email: info@brunner.de

Technical and assortment changes as well as errors and misprints reserved.
Reprinting and reproduction, even in part, only with the express permission of the publisher.

Art. Nr.: 19862